



D Series DIGITAL ELECTRONIC RADIATOR

INSTRUCTION MANUAL

Information, operation & installation



ECODESIGN

ACHIEVES & EXCEEDS ALL EFFICIENCY REGULATIONS

WWW.ECODESIGNHEATING.COM

LOT
20
READY



wifinside



e-life
technology



EAC



CE

Contents:

1. Introduction.....	3
2. Product information and operation	3
2.1. Control panel	3
2.2. Switching on and off (stand-by)	5
2.3. Adjust the day and time	5
2.4. Adjust the temperature	6
2.5. Lock the control panel	6
2.6. Main Menu.....	7
2.6.1. Settings sub-menu	7
2.6.2. Energy sub-menu.....	8
2.6.3. Equilibrium / Balance sub-menu	10
2.6.4. Program sub-menu.....	10
2.7. OPEN WINDOWS function.....	15
2.8. Fuzzy Logic Energy Control technology	16
3. Installation and mounting	16
3.1 Mounting instructions	16
3.2 Installing and fixing the supports.....	17
4. Maintenance and cleaning	18
5. Installation and safety precautions	18
5.1. Installation precautions.....	18
5.2. Safety precautions.....	18
6. Rointe Product Guarantee.....	19
7. European Directive.....	21
8. Information requirements for Erp Directive. Commission Regulation (EU) 2015/1188.....	22
9. Dimensions & Technical Characteristics.....	24
10. Certificate of Guarantee.....	25



1. Introduction

Designed with the user in mind, this product contains an exclusive electronic temperature programmer and is manufactured with high quality components. This product has passed the most demanding quality controls to meet rigorous safety standards and efficiency requirements. This product is designed for fixed installation only. The main features of this product are:

- 1.77" TFT Screen with personalisable background colours
- Safety thermostat
- Low consumption due to patented Fuzzy Logic Energy Control technology
- Integrated Wi-Fi module with E-Life technology
- Highly sensitive touch control panel
- 100% aluminium body and closures designed exclusively for Rointe
- Equilibrium function
- OPEN WINDOWS function

IMPORTANT - Please read this Instruction manual carefully to ensure correct operation. It is important that the installer reads and understands these instructions, and unpacks and familiarises themselves with the equipment before commencing the installation. This manual must be left with the product after installation. Failure to observe these installation instructions could render the guarantee null and void.

2. Product information and operation

2.1. Control panel

2.1.1. Keypad

ICON	DESCRIPTION
	On / Off button Accept / Confirm button
	Decrease temperature button Move left button
	Increase temperature button Move right button
	Menu button Move upwards button
PROG	PROGRAMME button Move downwards button







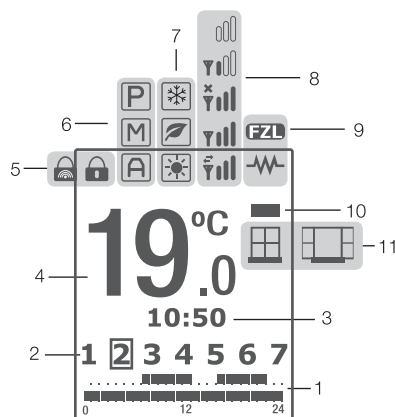















2.1.2. Display panel

NO.	DESCRIPTION
1	Programming
2	Days of the week
3	Time of day
4	Temperature selected
5	Control panel locked / unlocked
6	MANUAL / AUTOMATIC / PILOT WIRE* function indicator
7	COMFORT / ECO / ANTI-FROST mode indicator
8	Wi-Fi connection status indicator
9	Heating element active indicator / Fuzzy Logic Energy Control technology indicator
10	Energy consumption indicator
11	OPEN WINDOWS function indicator







* PILOT WIRE function not available in UK. Only on demand.*

2.1.3. Icon information

ICON	DESCRIPTION	ICON	DESCRIPTION
	Heating element active		MANUAL function active
	OPEN WINDOWS function - active, detection		PILOT WIRE function active*
	OPEN WINDOWS function - active no detection		AUTOMATIC function active when USER mode active
	Energy consumption status - green / amber / red		MANUAL function active when USER mode active
	Fuzzy Logic Control technology active		PILOT WIRE function active* when USER mode active
	COMFORT mode active		Connected to the server and router - sending and receiving.
	ECO mode active		Connected to the server and router - maximum net signal.
	ANTI-FROST mode active		Connected to the server and router - minimum net signal.
	Control panel locked through keypad		Connected to router. Not connected to the server.
	Control panel locked through remote		Not connected to the server or to the router.
	AUTOMATIC function active	* PILOT WIRE function not available in UK. Only on demand.*	



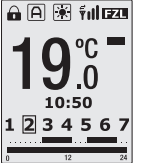





















2.2. Switching on and off (stand-by)

<p>To switch the product on, please press the  button on the keypad once.</p> <p>The image to the right will appear on the display panel when the product is switched on.</p>	
<p>After 5 seconds the temperature, time and days of the week will show on the display panel.</p>	
<p>To switch the product off, please press the  button again once.</p> <p>The product will go into stand-by mode with the word 'STAND-BY' displayed on the display panel. After 5 seconds the Rointe logo will appear.</p>	

2.3. Adjust the day and time

You can manually set the time on the product from the control panel or it will automatically synchronise when the product has been connected to Wi-Fi and Rointe Connect app.

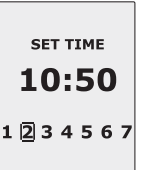

<p>To set the day and time, please press the  button on the keypad to access the Main Menu. Select the 'Settings' menu  using the  or  buttons on the keypad.</p> <p>To move left press the  button and to move right press the  button. Once the  icon is highlighted on the display panel, press the  button to access.</p>	
<p>Now use the  and  buttons again to select the clock option  and press  to access.</p>	
<p>Use the  and  buttons to set the hour and then press  to confirm. Then use the  and  buttons to set the minutes and press  to confirm. Finally, use the  and  buttons to set the day (1 = Monday, 2 = Tuesday etc.) and confirm by pressing the  button.</p>	

2.4. Adjust the temperature

To change the temperature, please press the <- or +> button. To decrease the temperature press the <- button and to increase the temperature press the +> button.

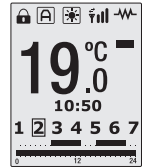
When the room temperature is lower than the set temperature on the display panel, the product will come on with the  symbol appearing in the top right of the display panel.



When the Fuzzy Logic Energy Control technology is activated the symbol  will replace the symbol  in the top right of the display panel.

To learn more about Fuzzy Logic Energy Control technology please see section 2.8.

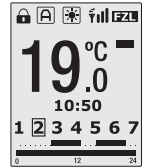

2.5. Lock the control panel

You can lock the keypad from the product or from a remote control* (optional).

To lock the keypad manually, please hold and press the <- button AND the +> button TOGETHER for 3 seconds. The  symbol will appear on the display panel and the keys will not respond.

To unlock the keypad manually, please hold and press the <- button AND the +> button TOGETHER for 3 seconds. To lock the keypad using a remote control, please see the corresponding instruction manual for the remote control separately.



Please note that if the product is locked using a remote control then it can only be unlocked using the remote control. If the product is locked using a remote control and you press the keypad on the product then the following image will appear on the display panel.





2.6. Main Menu

The Main Menu is accessed by pressing the menu button. You can navigate through the different options available on the menu by pressing the and buttons to move left and right respectively and to scroll through all 4 options.

The selected sub-menu will be highlighted with a frame, as shown in the image to the right on the 'Settings' section of the display panel.

The below icons displayed on the screen take you to the following sub-menus:



Settings	Energy	Equilibrium/ Balance	Program

2.6.1. Main Menu: Settings sub-menu

The 'Settings' sub-menu configures the technical parameters of your product. To access, select the icon displayed in the Main Menu screen and press to confirm.

Use the and buttons to move across the different options on the sub-menu to choose your parameter and press to access.

The below icons displayed on the screen take you to the following parameters:



Display backlight brightness	Wi-Fi settings	Language	Time

- Adjust display backlight brightness**

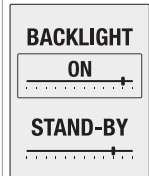

This allows you to change the brightness of the display panel in both the STAND-BY and ON modes separately. To change the brightness of the display panel ensure the icon is highlighted and press the button to confirm. Then with the and PROG buttons you can switch between the two modes.

With the and buttons you can increase or decrease the brightness as you wish. The cursor indicates the intensity of the light. Once you have set the required brightness press the button to save and exit.



• Wi-Fi settings

This prepares the product to communicate with the selected Wi-Fi network.



To start the PAIRING mode, ensure the  icon is highlighted and press the  button to confirm. On the next screen the name of the network (NET) and password (PIN) will appear. Press the button  to exit the pairing mode and return to the main screen.



NET: ROR_0001
PIN: 12345678

000000000000
000000000000

Please note - to pair your product with your home internet network please follow the instructions in the "D SERIES Heating System Quick Setup Guide" enclosed.

• Change the language

To change the language of your product, ensure the  icon is highlighted in the 'Settings' sub-menu and press the  button to access.

Use the  and PROG buttons to move up or down respectively until your chosen language is highlighted and confirm by pressing the  button.

LANGUAGE
ENGLISH
FRANÇAIS
ESPAÑOL
PORTUGUÊS



• Adjust the day and time





This option sets the hour, minutes and day of the week in your product. Please refer to section 2.3.

SET TIME
10:50
1 2 3 4 5 6 7

2.6.2. Main Menu: Energy sub-menu





The 'Energy' sub-menu provides access to functions related to energy management of the product. To access, select the  icon displayed in the Main Menu screen and press  to confirm.

Use the  and  buttons to move across the different options on the sub-menu to choose your function and press  to confirm. The below icons displayed on the screen take you to the following functions:

				
OPEN WINDOWS function	Rointe Eye Detect function * Not available in UK. Only on demand*	Effective Power function	Information	





• **OPEN WINDOWS function**

To set the OPEN WINDOWS* function, ensure the  icon is highlighted in the 'Energy' sub-menu and press the  button to access. Use the  and PROG buttons to move up or down respectively until your preference is highlighted and confirm by pressing the  button. *To learn more about this function, please go to section 2.7.



OPEN WINDOWS
ON
OFF

• **Rointe Eye Detect function** (*Not available in UK. Only on demand.*)

Allows you to enable or disable the Rointe Eye Detect function. Using the  and PROG buttons select ON to activate or OFF to disable. Once the desired option is selected press  to confirm and return to the main display.

EYE DETECT
ON
OFF

• **Effective Power function**

To check the Effective Power status of your product, ensure the  icon is highlighted in the 'Energy' sub-menu and press the  button to access. The display panel will then show a status according to the current state of consumption of the product:

- Working Time
- Total Time

After 6 seconds, the display panel will then show:





- Nominal Power (w)
- Effective Power* (w)

*The effective power is the actual value of its nominal power that the product consumes during periods of operation.

WORKING TIME 000001h
TOTAL TIME 000001h
POWER(W) 1600
EFFECTIVE POWER(W) 640

• **Information**

This function will display the software version, the date of this release and the rated power of the product.

To access this information, ensure the  icon is highlighted in the 'Energy' sub-menu and press the  button to confirm. The information will then show in the display panel. To exit press the  button or press the  button again to move onto the next display in the Information function.

SOFTWARE VERSION V1.00
19/02/2015 POWER 1100W

The next display in the Information function displays the Wi-Fi connection status, the connection type, IP address, subnet mask and gateway.

To exit press the  button or press the  button again to move onto the next display in the Information function.



WIFI STATUS
dhcp:assigned
IP, NM, GW:
 XXX.XXX.X.XXX
 XXX.XXX.XXX.X
 XXX.XXX.X.XXX

The final display in the Information function displays the MAC and RSSI address, signal strength measured in dbm.

To exit press the  button.

WIFI STATUS
MAC:
 0 :50:93
 C4:03:F6
RSSI:-70

2.6.3. Main Menu: Equilibrium / Balance sub-menu

The 'Balance' sub-menu/function returns the product to a constant temperature of 19°C. To activate this function ensure the  icon is highlighted in the 'Balance' sub-menu and press the  button to confirm.

The product will return to the display panel in MANUAL function, with the temperature set to 19°C.

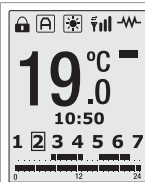



2.6.4. Main Menu: Program sub-menu

This section explains the operational aspects of your product in its various functions and modes.



What are the functions of MANUAL, AUTOMATIC and PILOT WIRE functions?



MANUAL	This function allows you to change the product between the COMFORT, ECO and ANTI-FROST modes and to change the temperature (see section 2.4.).
AUTOMATIC	This function will activate the programming that has previously been set in the product.
PILOT WIRE	This function allows the product to be controlled by a central programmer. * Not available in UK. Only on demand*

What are the COMFORT, ECO and ANTI-FROST modes?

 COMFORT	 ECO	 ANTI-FROST
From 19°C to 30°C	From 7.5°C to 18.5°C	7°C



The 'Program' sub-menu provides access to functions related to programming the product. To access, select the  icon displayed in the Main Menu screen and press  to access.





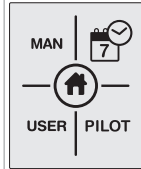

Use the  and  buttons to move across the different options on the sub-menu to choose your program and press  to access.

The icons displayed on the screen take you to the following functions:



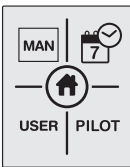



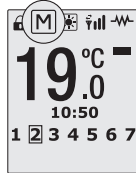
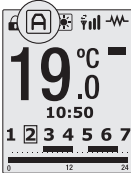

MAN/AUTO		USER	PILOT
MANUAL / AUTOMATIC functions	Programming options	USER mode	PILOT WIRE function * Not available in UK. Only on demand.*

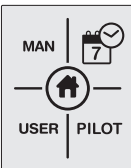
• **MANUAL / AUTOMATIC functions**

To change or choose the MANUAL or AUTOMATIC function, ensure the MAN/AUTO icon is highlighted in the 'Program' sub-menu and press the  button to confirm. You can change from AUTOMATIC to MANUAL and vice versa by pressing the  button again.		
On the display panel, the symbol  will appear for the AUTOMATIC function and the symbol  for the MANUAL function.		





• **Programming options**

To choose a program for your product you MUST be in AUTOMATIC mode. Please see previous section for details on how to adjust to AUTOMATIC mode.	
To access the 'Programming' options, ensure you are in the 'Program' sub-menu, then select the  icon by using the  and  buttons and then press the  button once the  icon is highlighted.	

- Start programming for AUTOMATIC function



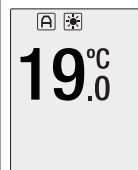

To program the AUTOMATIC mode, see points above and ensure that START PROGRAMMING is highlighted. Press the  button to access and the display panel will show a flashing screen.

STEP 1 - Select COMFORT mode temperature

 COMFORT mode will be programmed first. Select the COMFORT mode temperature between 19°C and 30°C using the  and  buttons. The  icon and the temperature will flash. Press the  button to confirm.





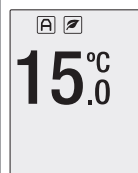

STEP 2 - Select ECO mode temperature

 ECO mode will be programmed next. Select the ECO mode temperature between 7.5°C and 18.5°C using the  and  buttons.. The  icon and the temperature will flash. Press the  button to confirm.







STEP 3 - Select the Days

The days of the week will start flashing on the display panel and show as DAY 1, DAY 2, DAY 3 etc.

Use the  and  buttons to move forwards or backwards through the days. Press  to select the day or days that you wish to include in your AUTOMATIC program. The day will stop flashing once selected. Repeat for all the days you wish to program and once all days are selected press the button  to move onto setting the hour.



STEP 4 - Select the Hours

Once step 3 has been completed, 0h appears on the display panel. 0h is equal to midnight. Use the  or  buttons to select the hour you wish to change. Use the  button to change the mode (COMFORT, ECO or nothing) for the hour you wish to modify. The corresponding icon for that mode will appear at the top of the screen. To finish the programming press  or leave for 30 seconds without pressing any buttons. To change the programming go back to step 1 and proceed as described before.

*If you wish to have individual days with different programming within your program you will need to modify each day separately, starting from the Main Menu again for each day/days. Follow Steps 1 to 4 above to program multiple differing days/ hours/temperatures.





• **USER mode**

To enter the USER function, ensure the **USER** icon is highlighted in the 'Program' sub-menu and press the button to access. A 4-digit PIN code is required in order to access the menu. The default PIN is 0000.

To enter the PIN use the and and and PROG buttons to move left, right, up or down to select the correct numbers, pressing after each number is highlighted to confirm. Once the full 4 digits have been entered, move to OK on the display panel and press the button to confirm. Once the PIN number has been entered correctly, the main USER function sub-menu will be shown.

The below icons displayed on the screen take you to the following functions:

ENABLE / DISABLE functions	Change PIN	Upper temperature limit	Lower temperature limit

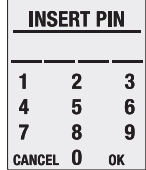

• **Enable / Disable functions**

To access the Enable/Disable function, ensure the icon is highlighted in the 'Program' sub-menu and press the button to access.



Use the and PROG buttons to move up and down respectively to select ON to enable or OFF to disable. Once the desired option is highlighted press the button to confirm. Use the button to go back to the main display panel or leave for 30 seconds without pressing any buttons.



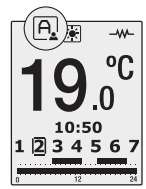
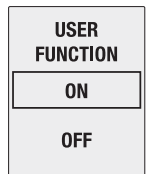

On the main screen you will see the icon in AUTOMATIC function, the icon in MANUAL function and when in PILOT WIRE* function.

PILOT WIRE function not available in UK. Only upon demand.



- **Change the PIN code**

To change the PIN code of your product, ensure the  icon is highlighted in the 'Program' sub-menu and press the  button to access.

Use the  and  and  and  buttons to move left, right, up or down to select the new numbers, pressing  after each number is highlighted to confirm.



Then move to OK on the display panel and press the  button to confirm. The screen will show PIN CHANGED.



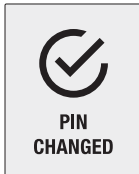

Please remember your new PIN code for the future and store in a safe place. In order to access the USER function menu again you will need your new PIN code.

NEW PIN		
1	2	3
4	5	6
7	8	9
CANCEL	0	OK





- **Upper temperature limit**



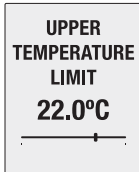

To set the upper temperature limit of your product ensure the  icon is highlighted in the 'Program' sub-menu and press the  button to access.

Use the  and  buttons to decrease or increase your desired upper temperature between 19°C to 30°C and press the  button to confirm. You will then return to the USER function screen. To exit press the  button to go back to the main display panel or leave for 30 seconds without pressing any buttons.



- **Lower temperature limit**

To set the lower temperature limit of your product ensure the  icon is highlighted in the 'Program' sub-menu and press the  button to access.



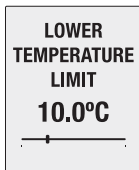



Use the  and  buttons to decrease or increase your desired lower working temperature between 7.5°C to 18.5°C and press the  button to confirm. You will then return to the USER function screen. To exit press the  button to go back to the main display panel or leave for 30 seconds without pressing any buttons.









- **PILOT WIRE function** (*Not available in UK. Only on demand.*)

The PILOT WIRE function allows your heating only to be controlled via a pilot wire programmer.

<p>To access the PILOT WIRE mode, ensure the PILOT icon is highlighted in the 'Program' sub-menu and press the  button to access.</p> <p>Use the  and PROG buttons to move up and down respectively to select ON to enable or OFF to disable. Once the desired option is highlighted press the  button to confirm. Use the  button to go back to the main display panel or leave for 30 seconds without pressing any buttons.</p> <p>On the main display panel the symbol  will appear.</p>	<div style="border: 1px solid black; padding: 5px; text-align: center;"> <p>PILOT WIRE</p> <div style="border: 1px solid black; padding: 2px; margin: 2px;">ON</div> <div style="border: 1px solid black; padding: 2px; margin: 2px;">OFF</div> </div> 
--	--

2.7. OPEN WINDOWS function

This function is activated when the temperature sensor in the product detects a drop of 4°C from the set temperature within a 30 minute time period. The OPEN WINDOWS function will be active for 2 hours. If the  button is pushed during this period the product will switch off. Pushing the button  again will switch on the product without the OPEN WINDOWS function being switched on.

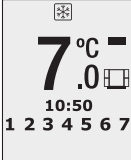
<p>When this function is activated by the sensor, the image to the right will appear on the product display panel for 5 seconds.</p>	<div style="border: 1px solid black; padding: 5px; text-align: center;"> <p>OPEN WINDOW</p>  </div>
<p>When the OPEN WINDOWS function is activated, the product will move into ANTI-FROST mode at 7°C. The  icon will appear on the product display panel showing that the ANTI-FROST mode is active.</p>	

2.8. Fuzzy Logic Energy Control technology

Fuzzy Logic Energy Control is a technology developed by Rointe to improve the energy management required to maintain a stable temperature, analyzing its variations with an accuracy of ± 0.25 °C and sending micro electrons to the heating element that transfer the heat to the atmosphere in the most efficient way. When the  icon on the display panel is replaced with the **FZL** icon, then the Fuzzy Logic Energy Control technology has been activated and is working.

3. Installation and mounting

3.1. Mounting instructions

The product must never be installed directly below a power point. In bathrooms, the product must never be installed where the switches and/or other products may be within the reach of someone in the shower or bathtub.

The product works using natural air convection (Figure 1). In order to achieve optimal performance and an even distribution of heat, the product must be positioned according to the following table (Table 1). See Figure 2 for positioning.

Table 1:

PRODUCT PART	MINIMUM (cm)	MAXIMUM (cm)
	DISTANCE FROM FLOOR / WALL / BRICKWORK	
Lower	10 - 12	30
Sides	10 - 12	-
Upper	10 - 12	-

Figure 1:

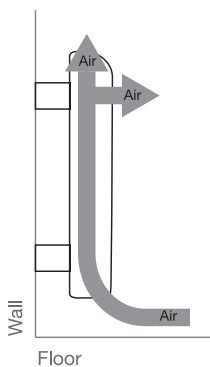
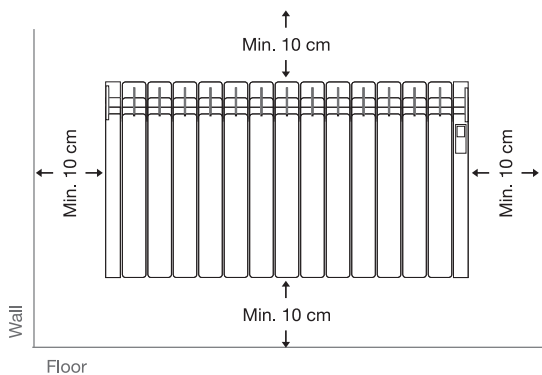

Figure 2:





3.2. Installation and fixing the supports

Inside the product packaging you will find a fixing kit so you can mount the product to the wall. Please follow these instructions carefully.

<p>Choose the right part of the wall (see section 3.1. for minimum distance from wall). Place the mounting stencil on the wall, marking the places for the holes.</p>	<p>Once you have marked the holes, remove the stencil and make the holes in the wall. Fix the supports using the plugs and screws provided (or others suitable for the wall type).</p>	<p>Check the positioning is correct of the lower support. Align the product with the top supports. Once aligned, place the product in the supports.</p>

Installing Template measurements dependent on the model:

DI*0330RAD

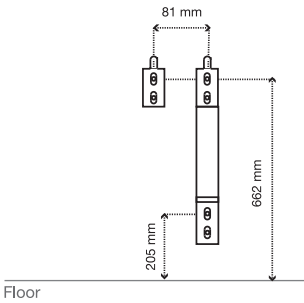

DI*0550RAD

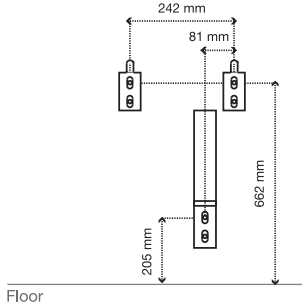

DI*0770RAD

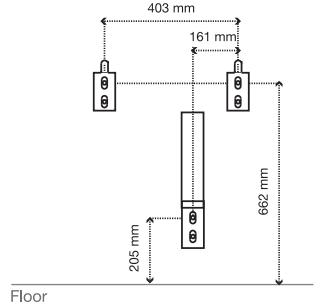

DI*0990RAD

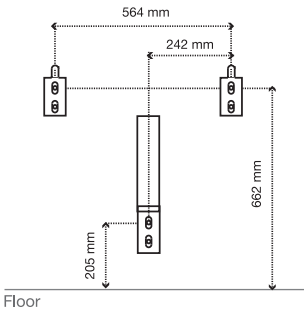

DI*1210RAD

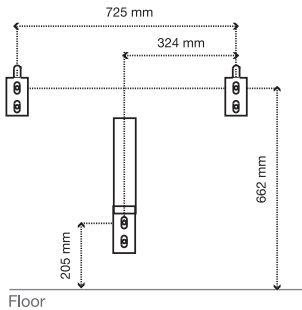

DI*1430RAD / DI*1600RAD

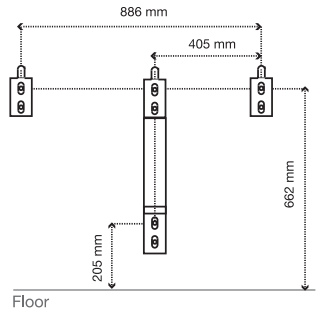

4. Maintenance and cleaning

The product does not require any type of regular maintenance. However, we recommend that all parts of the product are kept clean (behind, underneath, along the upper fins etc.). Do not use any abrasive product on the aluminium. Clean the aluminium with a damp cloth and a pH neutral soap. Clean the control panel with a dry cloth.

5. Installation and safety precautions (EN 60335 Standards)

Before switching on the product, please read the “Installation & Safety Precautions” in detail first to ensure the correct operation of the product.

5.1. Installation precautions

The product is designed for household or residential use only. You are advised to have the product installed by an authorized professional installer. Please contact Rointe by telephoning 0203 321 5928 to find your nearest installer. Make sure the product is properly connected to 230V and is earthed.

5.2. Safety precautions

The product can be used by children aged from 8 years and above and by persons with reduced physical sensory or mental capabilities or lack of experience and knowledge, if they are supervised or have been given instruction concerning use of the product in a safe way and understand the hazards involved. The product is not a toy, children should not play with the product. Cleaning and user maintenance should not be carried out by children without supervision. Children must be supervised at all times to ensure that they do not interfere with the product.

The product is filled with a precise amount of special thermal oil that does not need or require any maintenance. Any repairs requiring the opening of the oil tank must only be done by ROINTE or its official after-sales service personnel, who should also be notified should an oil leak be noticed. The regulations on discarding oil when the heater is being disposed of must be observed. If the power cable is damaged, it must be replaced by the manufacturer, its after-sales service or authorized personnel in order to avoid any damage.

WARNING - In order to avoid overheating, do not cover the product. Do not insert any kind of object in the air vents. Never use with wet hands. Do not place any containers with water, such as glasses or vases etc. on or near the product. Do not use insecticides, paints or aerosols on or near the product. Do not sit on the product or place anything in front of it.



6. Rointe Product Guarantee

In this section, we hereby describe the guarantee conditions, which the buyer acquires, on buying this product from ROINTE. These conditions comply with all the rights construed in the national legislation in force, as well as any additional rights and guarantees, which are offered by ROINTE.

Any incident that you might detect in your ROINTE product can be sorted by the product seller or quickly by the manufacturer. Please **contact ROINTE by telephoning 0203 321 5929 for Technical Support**. Alternatively, you can **email ROINTE at support@rointe.co.uk**, through which we will instruct you on how to solve the incident.

You will need to state the product reference (located on the label indicating product features), serial number, proof of purchase and the type of incident at hand when contacting us so that we can check the guarantee. In addition, please attach a copy of the product invoice.

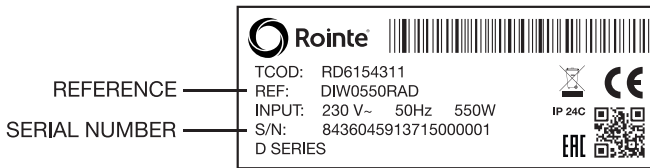

6.1. ROINTE guarantees that there are no material defects of design or manufacture at the time of original acquisition and guarantees the aluminium body for a period of 240 months and any electronic and electrical components for 36 months, provided that they have not been modified in any way.

6.2. If during the guarantee period, the product does not work correctly under normal use, and any design, material or manufacturing defect is found, ROINTE will repair or substitute the product as it may see fit, in accordance with the terms and conditions as follows:

6.2.1. The guarantee is only applicable if the original guarantee is issued by the seller and when the said guarantee is filled in correctly including product reference, series number (marked on the product’s label indicating technical features), purchase date and the seller’s stamp, and either registered on our website at www.rointe.co.uk or returned completed to ROINTE within 90 days of installation. ROINTE reserves the right to reject the guarantee service when this information has been removed or modified after the original product purchase.

6.2.2. The guarantee is only applicable if the product has been installed by a competent person in accordance with this installation manual and all current regulations and codes of practice at the time of installation.

6.2.3. The guarantee is only applicable to those cases that concern material, design and manufacturing defects, and under no circumstances covers damage to the product for the following reasons:

6.2.3.1 Damage caused by negligence and/or misuse of the product, i.e. used for other purposes that are not construed as its normal use or for not respecting the instructions of use and maintenance given by ROINTE as well as incorrect installation or use of the product that may not comply with the current technical standards of safety.

6.2.3.2. Corrosion of any part of the product caused by direct exposure to salt water. When the product is installed no more than 200m from the coast the guarantee for damages caused by corrosion the period will be reduced by 50%.

6.2.3.3. Any unauthorised modification of the product or repairs of the product carried out by third parties or unauthorised technicians or opening of the product by third parties or unauthorised people.

6.2.3.4. Any accidents that are deemed outside the control of ROINTE, such as (but not limited to): lightning, fires, floods, natural disasters, public disorder, atmospheric or geologic phenomena etc.

6.2.3.5. Faults that result from an incorrect installation. Guidance can be found within the recommendations for installation, by Rointe and in the installation manual. If in doubt, please contact ROINTE.

6.2.4. Any repairs or substitutions that are included in this guarantee do not allow any additions or new periods of guarantee.

6.2.5. Any repairs or substitutions covered under this guarantee must be parts that are functionally equivalent. The defective parts or parts removed or replaced shall become the property of ROINTE.

6.2.6. The product must be installed in a way that allows access for our technicians should they need to gain access to the product for repair or maintenance. The user/client is responsible for any costs or organisation required to provide access to the products for their repair and/or substitution.

6.3. The Technical Service department of ROINTE will advise you if you need to purchase any parts not covered under the guarantee or out of guarantee.

6.4. This guarantee will be null and void if the product: has been manipulated, modified and/or repaired in any way and/or by unauthorised persons. This guarantee will also be void if the product is not correctly installed.

6.5. This guarantee is not transferable and does not include claims due to frost or limescale damage.

6.6. Proof of purchase will be required to ROINTE for any claim.

6.7. This guarantee does not affect your statutory rights.

6.8. This guarantee does not affect the buyer's legal rights stipulated in the current national legislation, nor affects those rights against the distributor or installer that could come forth in compliance with the purchase contract.

6.9. In the absence of a national legal legislation applicable, this guarantee shall prevail and may be construed as the buyer's only protection. ROINTE, its offices, distributors and installers may not be held responsible for any accidental damage that emerges due to infringement of any rules implicitly related to this product.



6.10. Check the EULA conditions in the enclosed document for information about the legal agreement you accept when installing one of our D Series products.

For help about the product or guarantee, please **contact ROINTE by telephoning 0203 321 5929 for Technical Support** or by **email to support@rointe.co.uk**.

7. European Directive (WEEE) 2012/19/UE

Under the European Directive 2012/19/UE on Waste Electrical and Electronic Equipment (WEEE), the product cannot be disposed in the usual council bins and containers. They must be separated to optimize the recovery and recycling of all of the components and materials and reducing the impact to human health and the environment. The symbol of the container crossed out over a horizontal line is marked on all of ROINTE products to remind the consumer of the obligation to separate them on disposal. The consumer should contact the local authority or original point of sale to learn more about the correct disposal of this product.

8. Information requirements for Erp Directive. Commission Regulation (EU) 2015/1188.

Item	Symbol	Unit
HEAT OUTPUT		
Nominal heat output	P_{nom}	kW
Minimum heat output (indicative)	P_{min}	kW
Maximum continuous heat output	$P_{max,c}$	kW
AUXILIARY ELECTRICITY CONSUMPTION		
At nominal heat output	el_{MAX}	kW
At minimum heat output	el_{MIN}	kW
In standby mode	el_{SB}	kW
TYPE OF HEAT OUTPUT/ROOM TEMPERATURE CONTROL (SELECT ONE)		
Single stage heat output and no room temperature control		
Two or more manual stages, no room temperature control		
With mechanic thermostat room temperature control		
With electronic room temperature control		
Electronic room temperature control plus day timer		
Electronic room temperature control plus week timer		
OTHER CONTROL OPTIONS (MULTIPLE SELECTIONS POSSIBLE)		
Room temperature control, with presence detection		
Room temperature control, with open window detection		
With distance control option		
With adaptive start control		
With working time limitation		
With black bulb sensor		
SEASONAL SPACE HEATING ENERGY EFFICIENCY	η_s	

CONTACT DETAILS

ROINTE UK

Catalyst House, 720 Centennial Court, Centennial Park. Elstree, Herts, WD6 3SY
www.rointe.co.uk

T. 0203 321 5928 | F. 0208 953 5861

Technical Support: T. 0203 321 5929 | E: support@rointe.co.uk



DIW0330RAD DIB0330RAD	DIW0550RAD DIB0550RAD	DIW0770RAD DIB0770RAD	DIW0990RAD DIB0990RAD	DIW1210RAD DIB1210RAD	DIW1430RAD DIB1430RAD	DIW1600RAD DIB1600RAD
0,3	0,6	0,8	1,0	1,2	1,4	1,6
N.A.*	N.A.*	N.A.*	N.A.*	N.A.*	N.A.*	N.A.*
0,3	0,6	0,8	1,0	1,2	1,4	1,6
0,330	0,550	0,770	0,990	1,210	1,430	1,600
0,330	0,550	0,770	0,990	1,210	1,430	1,600
0,002	0,002	0,002	0,002	0,002	0,002	0,002
NO	NO	NO	NO	NO	NO	NO
NO	NO	NO	NO	NO	NO	NO
NO	NO	NO	NO	NO	NO	NO
NO	NO	NO	NO	NO	NO	NO
NO	NO	NO	NO	NO	NO	NO
YES	YES	YES	YES	YES	YES	YES
NO	NO	NO	NO	NO	NO	NO
YES	YES	YES	YES	YES	YES	YES
YES	YES	YES	YES	YES	YES	YES
YES	YES	YES	YES	YES	YES	YES
YES	YES	YES	YES	YES	YES	YES
NO	NO	NO	NO	NO	NO	NO
38,0%	38,8%	39,2%	39,3%	39,5%	39,5%	39,6%

*Not applicable

8. Dimensions & Technical Characteristics

MODEL	DI*0330RAD	DI*0550RAD	DI*0770RAD	DI*0990RAD	DI*1210RAD	DI*1430RAD	DI*1600RAD
No. Elements	3	5	7	9	11	13	15
DIMENSIONS, WEIGHTS & FINISHES							
Width (mm)	350	510	675	835	992	1,160	1,320
Height (mm)	585	585	585	585	585	585	585
Depth (mm)	97	97	97	97	97	97	97
Installed Depth (mm)	120	120	120	120	120	120	120
Weight (kg)	7.7	12.2	16.4	20.4	24.1	25.9	32.1
Finish	White RAL 9016 / Graphite Forge Effect / RAL Colour						
ELECTRICAL CHARACTERISTICS							
Nominal Power (W)	330	550	770	990	1,210	1,430	1,600
Effective Power (W)	125	209	293	376	460	543	608
Voltage (V)	230 ~V	230 ~V	230 ~V	230 ~V	230 ~V	230 ~V	230 ~V
Current (A)	1.5	2.4	3.4	4.3	5.3	6.2	7.0
Power per Elem.(W/ Element)	110	110	110	110	110	110	110
PERFORMANCE , INSTALLATION & SECURITY							
Safety thermostat	✓	✓	✓	✓	✓	✓	✓
Protection Grade	IP 24C	IP 24C	IP 24C	IP 24C	IP 24C	IP 24C	IP 24C
Template & Installation Kit	✓	✓	✓	✓	✓	✓	✓
WHITE	8436045913708	8436045913715	8436045913722	8436045913739	8436045913746	8436045913753	8436045913760
GRAPHITE	8436045913777	8436045913784	8436045913791	8436045913807	8436045913814	8436045913821	8436045913838
CODES	8436045916235- xxxx	8436045916242- xxxx	8436045916259- xxxx	8436045916266- xxxx	8436045916273- xxxx	8436045916280- xxxx	8436045916297- xxxx

Cut along the dotted line



CERTIFICATE OF GUARANTEE



In the event of any defect being detected in the product within the period of guarantee, you must fill in the below Certificate of Guarantee and send it to us stamped together with a copy of the sales invoice via email to support@rointe.co.uk or to the following postal address: INDUSTRIAS ROYAL TERMIC, S.L., C/E, Parcela 43, 30140 Santomera (Murcia, Spain).

CERTIFICATE OF GUARANTEE	
REFERENCE:	N° SERIES: PURCHASE DATE:
USER:	
HOME ADDRESS:	
TOWN:	POSTCODE:
COUNTY:	COUNTRY:
TELEPHONE:	EMAIL:
SELLER'S STAMP:	

NB: This certificate of Guarantee MUST be completed in full in order to obtain guarantee rights. The purchase date and seller's stamp are compulsory. Please attach a copy of your sales invoices. In addition, for new constructions include the Certificate of First Occupation.



Thank you for choosing Rointe. We hope you enjoy your product.

If you require further assistance or information, please contact our Technical Service Department by telephoning **0203 321 5929** or email **support@rointe.co.uk**.

ROINTE UK

Catalyst House,
720 Centennial Court, Centennial Park
Elstree, Herts, WD6 3SY

T. 0203 321 5928

F. 0208 953 5861

Technical Support

T. 0203 321 5929

E: support@rointe.co.uk

www.rointe.co.uk

