

devola

Comfortable living everyday

Instruction Manual

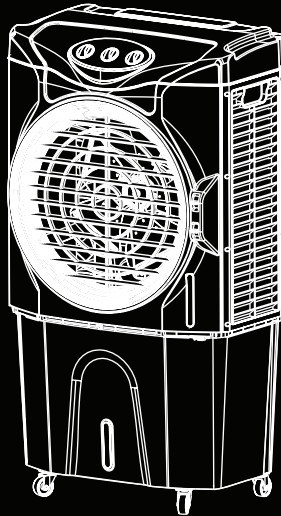

Devola 80L Swamp Air Cooler

DVCO80P



devola.co.uk

WARNINGS & SAFETY RULES

WARNING: This appliance is intended for indoor use only. It is suitable for use in domestic and commercial environments. Any other use is not recommended by the manufacturer and may cause fire, electrical shocks or other injury to person or property.

When using electrical appliances, basic safety precautions should always be followed:

1. Extreme care should be taken when using the product near children, and whenever the product is left unattended.
2. Before operating the product remove the unit from its packaging and check it is in good condition.
3. Do not let children play with the packaging, for example plastic bags.
4. If the supply cord is damaged it must be replaced by the Manufacturer or an authorized service centre in order to avoid a hazard.
5. Do not attempt to repair or adjust any electrical or mechanical functions on this unit as this may void warranty.
6. Check the household voltage to ensure it matches the units rating plate specification before operating.
7. Do not cover, or block any of the air outlets.
8. Always switch off and unplug the product before refilling the watertank.
9. Always unplug the product when not in use. To disconnect the power supply, grip the plug and pull from the power socket. Never pull by the cord.
10. This product is not intended for use in wet or damp locations. Never locate the product where it may fall into a bathtub or other water container.
11. Do not use in bathrooms or outdoors. When not in use always store in a dry area.
12. Do not run power cord under carpeting, or cover with rugs or runners. Arrange the cord away from areas where it may tripped over.
13. Avoid the use of an extension cable as this may overheat and cause a fire.
14. Do not insert or allow objects to enter any ventilation or exhaust opening as this may damage the product and could cause an electrical shock or fire.
15. Do not use the product in areas where gasoline, paint, or other inflammable goods and objects are present.
16. This appliance is not intended for use by persons (including children or elderly) with reduced physical, sensory or mental capabilities, or lack of experience and knowledge, unless they have been given supervision or instruction concerning use of the appliance by a person responsible for their safety.
17. Children should be supervised to ensure that they do not play with the appliance, if the supply cord are damaged, it shall be replaced by the manufacturer or agent.

SAVE AND READ THESE IMPORTANT SAFETY INSTRUCTIONS

IMPORTANT PRODUCT INFORMATION

This product combines a room cooler, a humidifier and air cleaner, which means that it can be used all year round. To obtain the best cooling effect from your product please read these instructions carefully.

Your cooler requires a fresh air supply

1. Locate the cooler near an open window or leave the door to the room open. Then open another outside window or door on the opposite side of the room, so that you create "flow through" ventilation. The cooler will not work properly in a closed room.
2. Start your cooler before the air temperature in the room reach unacceptable levels. Due to the low running costs of the unit, it is more effective to leave the unit running during periods of occupation.
3. Add cold water to the tank. Ice may be added if available. Turn on the cool switch and the filter pad will become damp. The air is drawn in through the rear panel and over the filter pad to release cool clean air. It may take a few minutes for the pad to become saturated.

If the air become too humid you may use the cooler as a simple fan. This is achieved by turning the cooler on, but not using the cool button.

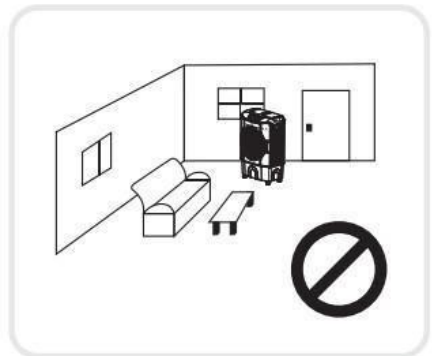
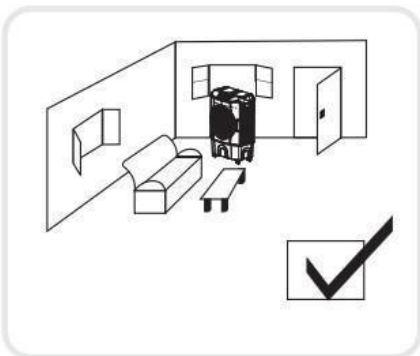

PARTS DESCRIPTION

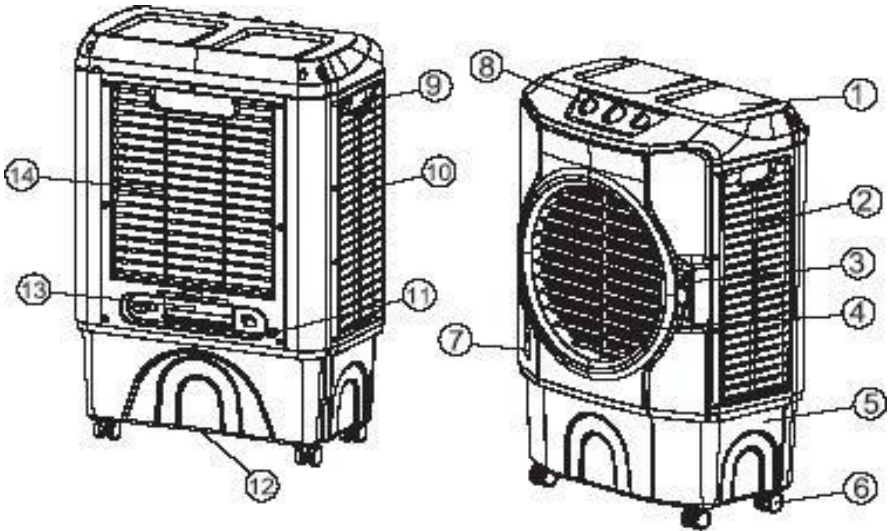

- | | |
|---------------------------------|----------------------------|
| 1) Top Panel | 8) Control Panel |
| 2) Right Panel | 9) Handle |
| 3) Lever For Horizontal Louvers | 10) Left Panel |
| 4) Horizontal Louvers | 11) Continuous Water Inlet |
| 5) Water Tank | 12) Drain Plug |
| 6) Castors | 13) Water Inlet |
| 7) Water Level Indicator | 14) Back Panel |

CONTROL PANEL

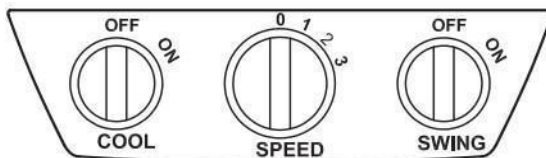

OPERATING INSTRUCTIONS

OPERATING INSTRUCTIONS

1. Choose a suitable location for your Air Cooler. Please refer to the Important Product Information for details.
2. Your product may be operated by the manual controls located on the unit.
3. Fill water into the unit. Pour clean water in tank and if required, add some ice.
4. Connect to the power supply

FOR ROOM COOLING

- Turn the Speed knob to change the speed from 1 for Low to 2 for Medium to 3 for High.
- Turn the Cool knob to ON to start the cooling. It takes a few minutes to obtain the full effect from this mode.
- When the water tank is low turn the unit OFF and add more water and ice.
- To switch OFF the unit turn the Speed knob to 0. If you do not intend to use the product for some time empty the water tank.
- To empty the water tank turn your product off on the SPEED button, move the unit to a suitable location and remove the drain plug to allow water to flow out.

INSTALLING HOSE ADAPTER

- To attach a hose screw on the Hose connector supplier with the unit to the continuous water inlet.
- Verify that the Hose connector is screwed tight.
- Connect a 1/2" water hose (not supplied with the unit) to the Hose connector.
- Verify water tight connector by visually examining the connection.
- The maximal water inlet pressure is not more than 0.6 Mpa.

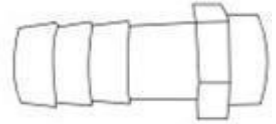

Hose connector

FILLING WATER

Water can be filled into the air cooler by

Continuous water supply

Connect a garden hose to the continuous water supply inlet

Manual operation

Water can be poured into the unit from the back

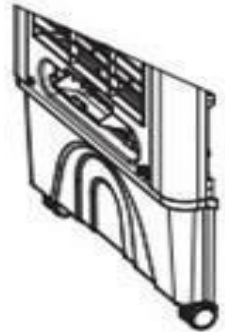

LOUVERES OPERATION

- Turn the SWING knob to ON or Press SWING button for moving the louver from side to side. This will improve the distribution of the cooler air in the room. To stop the louvers turn the SWING knob to OFF or Press SWING button.
- You can change the air direction(up or down) by manually adjusting the horizontal louvers.

SPECIFICATIONS

Model: DVCO60P

Voltage: 220-240V

Frequency: 50Hz

Wattage: 220W

CIRCUIT DIAGRAM

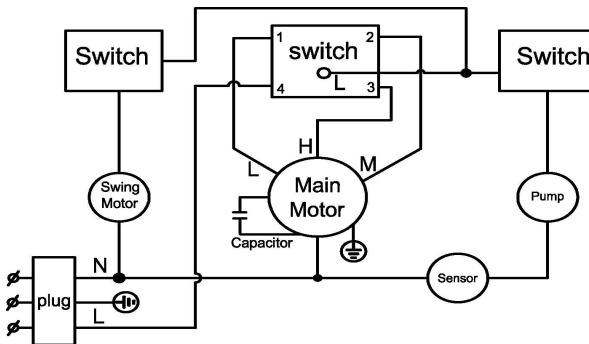

MAINTENANCE

- Before you clean the appliance, switch the product off, remove the plug for the power socket.
- Use a damp cloth to clean the product housing.
- Do not use water, detergents, abrasive cleaning liquids or chemical agents (Alcohol, Gasoline etc...) to clean the appliance.
- When not used for a long period of time store in the original packaging in a dry, dust free area during off season usage.



10% OFF

Use this discount code on your next order

COOL10



Scan for technical details



devola.co.uk

Unit 1, Reedswood Park Road, Walsall, West Midlands. WS2 8DQ

Helpline 0800 043 8975 Email info@devola.co.uk