



# KYROS



## INSTRUCTION MANUAL DIGITAL ELECTRONIC TOWEL RAIL

Information, operation & installation

### ECODESIGN

ACHIEVES & EXCEEDS ALL EFFICIENCY REGULATIONS

[WWW.ECODESIGNHEATING.COM](http://WWW.ECODESIGNHEATING.COM)

LOT  
20  
READY

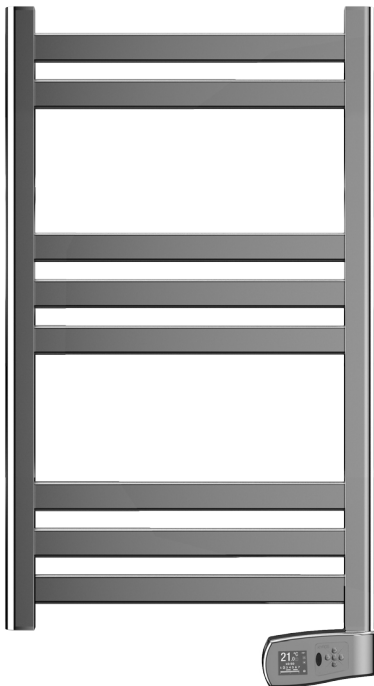

Class II

INFRARED CONTROL



CE

EAC

## Contents:

1. Introduction.....	3
2. Product information and operation .....	4
2.1. Control panel .....	4
2.2. Switching on and off (stand-by) .....	5
2.3. Adjust the day and time .....	6
2.4. Adjust the temperature .....	6
2.5. Lock the control panel .....	7
2.6. Main Menu.....	7
2.6.1. Settings sub-menu .....	8
2.6.2. Energy sub-menu.....	9
2.6.3. Equilibrium / Balance sub-menu .....	10
2.6.4. Program sub-menu.....	11
2.7. OPEN WINDOWS function .....	18
3. Installation instructions.....	19
3.1 Mounting instructions .....	19
3.2 Connecting instructions .....	19
3.3. Specific regulations for bathrooms.....	20
4. Maintenance and cleaning .....	21
5. Installation and safety precautions .....	21
5.1. Installation precautions.....	21
5.2. Safety precautions.....	21
6. Rointe Product Guarantee.....	21
7. European Directive.....	24
8. Dimensions & Technical Characteristics.....	24
9. Certificate of Guarantee.....	27



## 1. Introduction

Designed with the user in mind, this product contains an exclusive electronic temperature programmer and is manufactured with high quality components. This product has passed the most demanding quality controls to meet rigorous safety standards and efficiency requirements. This product is designed for fixed installation only. The main features of this product are:





- A backlit display
- Safety thermostat
- 4 pre-installed programmes
- Visual menus
- Infrared communication (compatible with AIR Control and BASIC Control remote controls)
- Equilibrium function
- OPEN WINDOWS function

**IMPORTANT** - Please read this Instruction Manual carefully to ensure correct operation. It is important that this manual is left with the product after installation.

## 2. Product information and operation

### 2.1. Control panel

#### 2.1.1. Keypad

ICON	DESCRIPTION
	On / Off button Accept / Confirm button
	Decrease temperature button Move left button
	Increase temperature button Move right button
	Menu button Move upwards button
	MANUAL / AUTOMATIC button Move downwards button







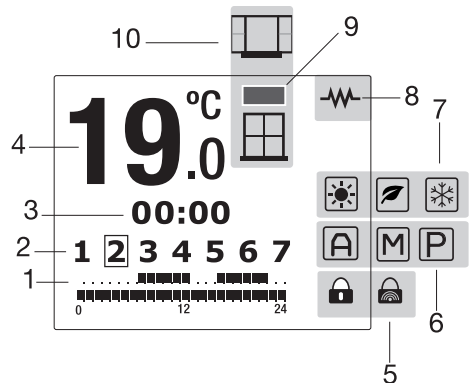









#### 2.1.2. Display panel

NO.	DESCRIPTION
1	Programming
2	Days of the week
3	Time of day
4	Temperature selected
5	Control panel locked / unlocked
6	MANUAL / AUTOMATIC / PILOT WIRE function indicator
7	COMFORT / ECO / ANTI-FROST mode indicator
8	Heating element active indicator
9	Energy consumption indicator
10	OPEN WINDOWS function indicator







\* PILOT WIRE function not available in UK. Only on demand.\*





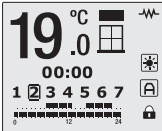



















### 2.1.3. Symbol information

SYMBOL	DESCRIPTION	SYMBOL	DESCRIPTION
	OPEN WINDOWS function - active no detection		MANUAL function active
	OPEN WINDOWS function - active, detection		PILOT WIRE function active <b>* Not available in UK. Only on demand.*</b>
	Energy consumption status - green / amber / red		AUTOMATIC function active when USER mode active
	Heating element active		MANUAL function active when USER mode active
	COMFORT mode active		PILOT WIRE function active when USER mode active <b>* Not available in UK. Only on demand.*</b>
	ECO mode active		Control panel locked through keypad
	ANTI-FROST mode active		Control panel locked through remote
	AUTOMATIC function active	<b>* PILOT WIRE function not available in UK. Only on demand.*</b>	





### 2.2. Switching on and off (stand-by)

<p>To switch the product on, please press the  button on the keypad once.</p> <p>The image to the right will appear on the display panel when the product is switched on.</p>	
<p>After 5 seconds the temperature, time and days of the week will show on the display panel.</p>	
<p>To switch the product off, please press the  button again once.</p> <p>The product will go into stand-by mode with the word 'STAND-BY' displayed on the display panel. After 5 seconds the Rointe logo will appear.</p>	

## 2.3. Adjust the day and time

<p>To set the day and time, please press the  button on the keypad to access the Main Menu. Select the 'Settings' menu  using the  or  buttons on the keypad.</p> <p>To move left press the  button and to move right press the  button. Once the  icon is highlighted on the display panel, press the  button to access.</p>	
<p>Now use the  and  buttons again to select the clock option  and press  to access.</p>	
<p>Use the  and  buttons to set the hour and then press  to confirm. Then use the  and  buttons to set the minutes and press  to confirm.</p> <p>Finally, use the  and  buttons to set the day (1 = Monday, 2 = Tuesday etc.) and confirm by pressing the  button.</p>	

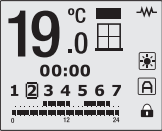

## 2.4. Adjust the temperature



<p>To change the temperature, please press the  or the  button. To decrease the temperature press the  button and to increase the temperature press the  button.</p> <p>When the room temperature is lower than the set temperature on the display panel, the product will come on with the  symbol appearing in the top right of the display panel.</p>	
---	--



## 2.5. Lock the control panel

You can lock the keypad from the product or from a remote control\* (optional).

To lock the keypad manually, please hold and press the  button AND the  button TOGETHER for 3 seconds. The  symbol will appear on the display panel and the keys will not respond.

To unlock the keypad manually, please hold and press the  button AND the  button TOGETHER for 3 seconds.

\*To lock the keypad using a remote control, please see the corresponding instruction manual for the remote control separately.





Please note that the product is locked using a remote control then it can only be unlocked using the remote control. If the product is locked using a remote control and you press the keypad on the product then the following image will appear on the display panel.



## 2.6. Main Menu





The Main Menu is accessed by pressing the menu  button.

You can navigate through the different options available on the menu by pressing the  and  buttons to move left and right respectively and to scroll through all 4 options.

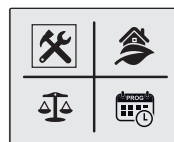

The selected sub-menu will be highlighted with a frame, as shown in the image to the right on the 'Settings'  section of the display panel.



The below icons displayed on the screen take you to the following sub-menus:





			
Settings	Energy	Equilibrium / Balance	Program

## 2.6.1. Main Menu: Settings sub-menu

The 'Settings' sub-menu configures the technical parameters of your product. To access, select the  icon displayed in the Main Menu screen and press  to confirm.





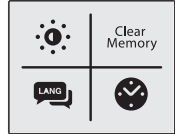

Use the  and  buttons to move across the different options on the sub-menu to choose your parameter and press  to access.

The below icons displayed on the screen take you to the following parameters:

	Clear Memory		
Display backlight brightness	Clear Memory	Language	Time



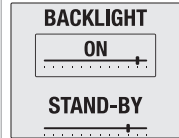

- **Adjust display backlight brightness**

This allows you to change the brightness of the display panel in both the STAND-BY and ON modes separately. To change the brightness of the display panel ensure the  icon is highlighted and press the  button to confirm. Then with the  and  buttons you can switch between the two modes. With the  and  buttons you can increase or decrease the brightness as you wish. The cursor indicates the intensity of the light. Once you have set the required brightness press the  button to save and exit.





- **Clear the memory**



This allows you to clear any information saved in your product. To clear the memory ensure the  icon is highlighted in the 'Settings' sub-menu and press the  button to confirm.

The display panel will show when completed and the language will change to default.



- **Change the language**

To change the language of your product, ensure the  icon is highlighted in the 'Settings' sub-menu and press the  button to access.

Use the  and  buttons to move up or down respectively until your chosen language is highlighted and confirm by pressing the  button.











- **Adjust the day and time**

This option sets the hour, minutes and day of the week in your product. Please refer to section 2.3.







### 2.6.2. Main Menu: Energy sub-menu

The 'Energy' sub-menu provides access to functions related to energy management of the product. To access, select the  icon displayed in the Main Menu screen and press  to confirm.

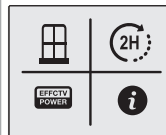

Use the  and  buttons to move across the different options on the sub-menu to choose your function and press  to confirm.



The below icons displayed on the screen take you to the following functions:



			
OPEN WINDOWS function	2 Hour BOOST function	Effective Power function	Information

- **OPEN WINDOWS function**

To set the OPEN WINDOWS\* function, ensure the  icon is highlighted in the 'Energy' sub-menu and press the  button to access.



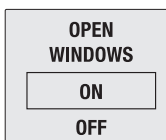

Use the  and  buttons to move up or down respectively until your preference is highlighted and confirm by pressing the  button.

\*To learn more about this function, please go to section 2.7.





- **2 Hour BOOST function**

The two hour BOOST mode will override any other set mode and will boost your product to maximum power. You can choose to boost to maximum power for 15 minutes, 30 minutes, 1 hour or 2 hours.

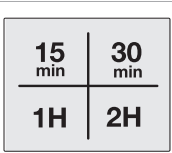
To set the BOOST mode, ensure the  icon is highlighted in the 'Energy' sub-menu and press the  button to access. Use the  and  buttons to choose how long to boost your product for and press  to confirm.



- **Effective Power function**

To check the Effective Power status of your product, ensure the  icon is highlighted in the 'Energy' sub-menu and press the  button to access.

The display panel will then show a status according to the current state of consumption of the product:

- Working Time
- Total Time



After 6 seconds, the display panel will then show:

- Nominal Power (w)
- Effective Power\* (w)

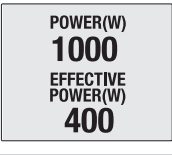
\*The effective power is the actual value of its nominal power that the product consumes during periods of operation.



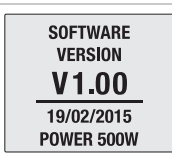

- **Information**

This function will display the software version, the date of this release and the rated power of the product. To access this information, ensure the  icon is highlighted in the 'Energy' sub-menu and press the  button to confirm. The information will then show in the display panel.



### 2.6.3. Main Menu: Equilibrium / Balance sub-menu

The 'Balance' sub-menu/function returns the product to a constant temperature of 19°C. To activate this function ensure the  icon is highlighted in the 'Balance' sub-menu and press the  button to confirm. The product will return to the display panel in MANUAL function, with the temperature set to 19°C.

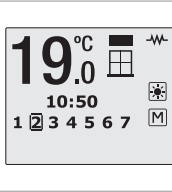



## 2.6.4. Main Menu: Program sub-menu









This section explains the operational aspects of your product in its various functions and modes.

### What are the functions of MANUAL, AUTOMATIC and PILOT WIRE functions?



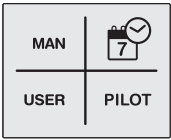

<b>MANUAL</b>	This function allows you to change the product between the COMFORT, ECO and ANTI-FROST modes and to change the temperature (see section 2.4.).
<b>AUTOMATIC</b>	This function will activate the programming that has previously been set in the product.
<b>PILOT WIRE</b>	This function allows the product to be controlled by a central programmer. * PILOT WIRE function not available in UK. Only on demand*

### What are the COMFORT, ECO and ANTI-FROST modes?





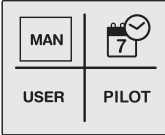
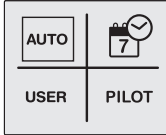

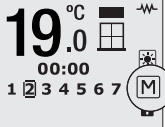
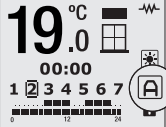





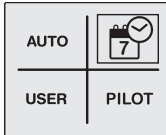

 COMFORT	 ECO	 ANTI-FROST
From 19°C to 30°C	From 7.5°C to 18.5°C	7°C

<p>The 'Program' sub-menu provides access to functions related to programming the product. To access, select the  icon displayed in the Main Menu screen and press  to access.</p> <p>Use the  and  buttons to move across the different options on the sub-menu to choose your program and press  to access.</p> <p>The icons displayed on the screen take you to the following functions:</p>								
<table border="1"> <tr> <td>MAN / AUTO</td> <td></td> <td>USER</td> <td>PILOT</td> </tr> <tr> <td>MANUAL/ AUTOMATIC functions</td> <td>Programming options</td> <td>USER mode</td> <td>PILOT WIRE function * Not available in UK. Only on demand.*</td> </tr> </table>	MAN / AUTO			USER	PILOT	MANUAL/ AUTOMATIC functions	Programming options	USER mode
MAN / AUTO		USER	PILOT					
MANUAL/ AUTOMATIC functions	Programming options	USER mode	PILOT WIRE function * Not available in UK. Only on demand.*					

## • MANUAL / AUTOMATIC functions

<p>To change or choose the MANUAL or AUTOMATIC function, ensure the <b>MAN/AUTO</b> icon is highlighted in the 'Program' sub-menu and press the  button to confirm. You can change from AUTOMATIC to MANUAL and vice versa by pressing the  button again.</p>		
<p>On the display panel, the symbol  will appear for the AUTOMATIC function and the symbol  for the MANUAL function.</p>		

## • Programming options

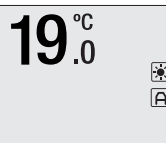

<p>To choose a program for your product you <b>MUST</b> be in AUTOMATIC mode. Please see previous section for details on how to adjust to AUTOMATIC mode. To access the 'Programming' options, ensure you are in the 'Program' sub-menu, then select the  icon by using the  and  buttons and then press the  button once the  icon is highlighted.</p>	
<p>The display panel will show 2 options:</p> <ul style="list-style-type: none"> <li>• PRE-PROGRAMS</li> <li>• START PROGRAMMING</li> </ul> <p>A flashing line will appear around the option that is selected. To change the option use the  and  buttons and press the  button to confirm.</p>	
<ul style="list-style-type: none"> <li>• Start programming for AUTOMATIC function</li> </ul> <p>To program the AUTOMATIC mode, see points above and ensure that START PROGRAMMING is highlighted. Press the  button to access and the display panel will show a flashing screen.</p> <p>STEP 1 - Select COMFORT mode temperature</p> <p> COMFORT mode will be programmed first. Select the COMFORT mode temperature between 19°C and 30°C using the  and  buttons. The  icon and the temperature will flash. Press the  button to confirm.</p>	

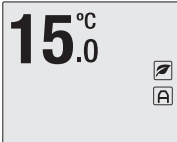
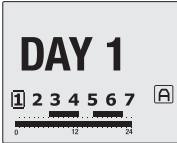
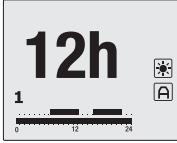

<p><b>STEP 2 - Select ECO mode temperature</b></p> <p> ECO mode will be programmed next. Select the ECO mode temperature between 7.5°C and 18.5°C. The  icon and the temperature will flash. Press the  button to confirm.</p>	
<p><b>STEP 3 - Select the Days</b></p> <p>The days of the week will start flashing on the display panel and show as DAY 1, DAY 2, DAY 3 etc.</p> <p>Use the  and  buttons to move forwards or backwards through the days. Press  to select the day or days that you wish to include in your AUTOMATIC program. The day will stop flashing once selected. Repeat for all the days you wish to program and once all days are selected press the button  to move onto setting the hour.</p>	
<p><b>STEP 4 - Select the Hours</b></p> <p>Once step 3 has been completed, 0h appears on the display panel. 0h is equal to midnight. Use the  or  buttons to select the hour you wish to change. Use the  button to change the mode (COMFORT, ECO or nothing) for the hour you wish to modify. The corresponding icon for that mode will appear at the top of the screen.</p> <p>To finish the programming press  or leave for 30 seconds without pressing any buttons. To change the programming go back to step 1 and proceed as described before.</p> <p>*If you wish to have individual days with different programming within your program you will need to modify each day separately, starting from the Main Menu again for each day/days. Follow Steps 1 to 4 above to program multiple differing days/hours/temperatures.</p>	

- PRE-PROGRAMS**

To activate a PRE-PROGRAM for your product ensure that PRE-PROGRAM is highlighted in the 'Program' sub-menu. Press the  button to confirm and the display panel will show 4 programs for you to choose from: A1, A2, A3 and A4.

Using the  and  buttons, choose the program you wish to activate and once highlighted, press the  button to confirm. You will then be automatically taken back to the main display panel and your pre-program option will show on the screen to confirm it is active.

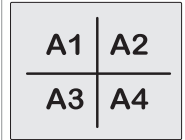

To MODIFY any of the pre-set programs:

You need to be in AUTOMATIC mode and select the pre-program you want to modify i.e. your product must be working/have the pre-program already activated you wish to modify.

Then ensure that START PROGRAMMING is highlighted. Press the  button to access and the display panel will show a flashing screen. You then need to follow STEPS 1 - 4 on pages 11 & 12 to modify the temperature/day/hours.

\*If you wish to have different days with different programming within your program you will need to modify each day separately, starting from the Main Menu again for each day/days. Follow STEPS 1 - 4 on pages 11 & 12 to program multiple differing days/hours/temperatures.

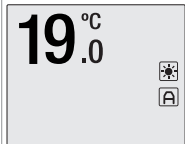



- Pre-installed programmes schedule:







PROGRAM	A1		A2		A3	A4	
	Mon - Fri	Sat - Sun	Mon - Fri	Sat - Sun	Mon - Sun	Mon - Fri	Sat - Sun
00:00							
01:00							
02:00							
03:00							
04:00							
05:00							
06:00	COMFORT		COMFORT		COMFORT		
07:00	COMFORT	COMFORT	COMFORT	COMFORT	COMFORT	COMFORT	ECO
08:00	COMFORT	COMFORT	COMFORT	COMFORT	COMFORT	COMFORT	ECO
09:00	COMFORT	COMFORT	COMFORT	COMFORT	COMFORT	COMFORT	ECO
10:00	ECO	COMFORT	ECO	COMFORT	COMFORT	COMFORT	ECO
11:00	ECO	ECO	ECO	ECO	COMFORT	COMFORT	ECO
12:00	ECO	COMFORT	COMFORT	COMFORT	COMFORT	COMFORT	ECO
13:00	ECO	COMFORT	COMFORT	COMFORT	COMFORT	COMFORT	ECO
14:00	ECO	COMFORT	COMFORT	COMFORT	COMFORT	COMFORT	ECO
15:00	COMFORT	COMFORT	ECO	COMFORT	COMFORT	COMFORT	ECO
16:00	COMFORT	ECO	COMFORT	ECO	COMFORT	ECO	ECO
17:00	COMFORT	ECO	COMFORT	ECO	COMFORT	ECO	ECO
18:00	COMFORT	ECO	COMFORT	ECO	COMFORT	ECO	ECO
19:00	COMFORT		COMFORT	COMFORT	COMFORT	ECO	ECO
20:00	COMFORT		COMFORT	COMFORT	COMFORT	ECO	ECO
21:00	COMFORT		COMFORT	COMFORT	COMFORT	ECO	ECO
22:00	COMFORT		COMFORT	COMFORT	COMFORT	ECO	ECO
23:00	ECO				ECO		

COMFORT	
ECO	
OFF	





- USER mode**

To enter the USER function, ensure the **USER** icon is highlighted in the 'Program' sub-menu and press the  button to access.

A 4-digit PIN code is required in order to access the menu. The default PIN is 0000.



To enter the PIN use the  and  and  and  buttons to move left, right, up or down to select the correct numbers, pressing  after each number is highlighted to confirm. Once the full 4 digits have been entered, move to OK on the display panel and press the  button to confirm. Once the PIN number has been entered correctly, the main USER function sub-menu will be shown.



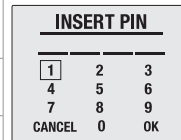

The below icons displayed on the screen take you to the following functions:



	 ****		
ENABLE / DISABLE functions	Change PIN	Upper temperature limit	Lower temperature limit



- Enable / Disable functions**

To access the Enable/Disable function, ensure the  icon is highlighted in the 'Program' sub-menu and press the  button to access.

Use the  and  buttons to move up and down respectively to select ON to enable or OFF to disable. Once the desired option is highlighted press the  button to confirm. Use the  button to go back to the main display panel or leave for 30 seconds without pressing any buttons.

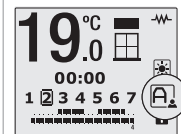
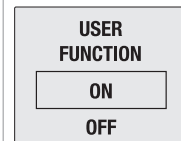

On the main screen you will see the  icon in AUTOMATIC function, the  icon in MANUAL function and  when in PILOT WIRE function.











- **Change the PIN code**

To change the PIN code of your product, ensure the  icon is highlighted in the `Program` sub-menu and press the  button to access.



Use the  and  and  and  buttons to move left, right, up or down to select the new numbers, pressing  after each number is highlighted to confirm.



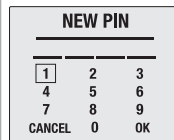

Then move to OK on the display panel and press the  button to confirm. The screen will show PIN CHANGED.

**Please remember your new PIN code for the future and store in a safe place. In order to access the USER function menu again you will need your new PIN code.**





- **Upper temperature limit**



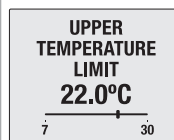

To set the upper temperature limit of your product ensure the  icon is highlighted in the `Program` sub-menu and press the  button to access.

Use the  and  buttons to decrease or increase your desired upper temperature between 19°C to 30°C and press the  button to confirm. You will then return to the USER function screen. To exit press the  button to go back to the main display panel or leave for 30 seconds without pressing any buttons.



- **Lower temperature limit**





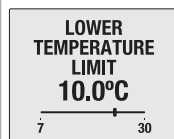

To set the lower temperature limit of your product ensure the  icon is highlighted in the `Program` sub-menu and press the  button to access.

Use the  and  buttons to decrease or increase your desired lower working temperature between 7.5°C to 18.5°C and press the  button to confirm. You will then return to the USER function screen. To exit press the  button to go back to the main display panel or leave for 30 seconds without pressing any buttons.





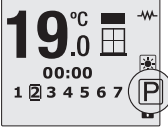

- **PILOT WIRE function** (\*Not available in UK. Only on demand.\*)

The PILOT WIRE function allows your heating only to be controlled via a pilot wire programmer.

<p>To access the PILOT WIRE mode, ensure the <b>PILOT</b> icon is highlighted in the 'Program' sub-menu and press the  button to access.</p> <p>Use the  and  buttons to move up and down respectively to select ON to enable or OFF to disable. Once the desired option is highlighted press the  button to confirm. Use the  button to go back to the main display panel or leave for 30 seconds without pressing any buttons.</p> <p>On the main display panel the symbol  will appear.</p>	<div data-bbox="891 337 1059 467"> <p><b>PILOT WIRE</b></p> <p>ON</p> <p>OFF</p> </div> <div data-bbox="891 500 1059 630">  </div>
--	--

## 2.7. OPEN WINDOWS function

This function is activated when the temperature sensor in the product detects a drop of 4°C from the set temperature within a 30 minute time period. The OPEN WINDOWS function will be active for 2 hours. If the  button is pushed during this period the product will switch off. Pushing the button  again will switch on the product without the OPEN WINDOWS function being switched on.

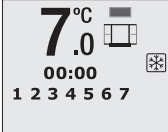
<p>When this function is activated by the sensor, the image to the right will appear on the product display panel for 5 seconds.</p>	<div data-bbox="891 987 1059 1117"> <p><b>OPEN WINDOW</b></p>  </div>
<p>When the OPEN WINDOWS function is activated, the product will move into ANTI-FROST mode at 7°C. The  icon will appear on the product display panel showing that the ANTI-FROST mode is active.</p>	<div data-bbox="891 1198 1059 1328">  </div>



### 3. Installation instructions

#### 3.1. Mounting instructions

Inside the box/packaging you will find a mounting kit:

1. Choose the right part of the wall.
2. Place the mounting stencil on the wall, marking the places for the holes.
3. Remove the stencil and make the holes in the wall.
4. Insert the rawl plugs in the holes made.
5. Screw the four metallic fasteners to the wall with the 6.3 x 50 mm screw.
6. Screw the four metallic cylinders to the product (see Figure 1).
7. Insert what you have assembled in Section 6 into the metallic fastener and fix well with the 2.9 x 9.5 mm stud bolt.

Figure 1:

NO.	ITEM
1	10mm rawl plug
2	Metallic fastener
3	Screw 2.9 x 9.5mm
4	Screw 6.3 x 50mm
5	Metallic cylinder
6	Product

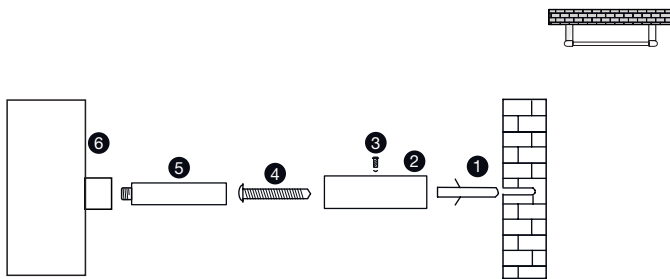

#### 3.2. Connecting instructions

Connection to the mains must be made observing the voltage stated on the product technical data label.

This product is designed to be permanently installed connected to fixed facilities. The product power supply circuit must have an all-pole circuit breaker switch with a separation of at least 3 mm between the contacts.

The product must be installed, if possible, away from any source of draughts (windows, doors) or any other thing which may affect its functioning. In this way, the temperature will not be affected. Place any object which might prevent the air flow (furniture, armchairs) 50 cm away from the front of the product.

The product must never be installed immediately below a power point.

The lower part of the control panel must be placed at least 15 cm from the floor.

For any product, if the power cable is damaged, it must be replaced by a specific cable. The replacement of the cable must be done by the maker, its after-sales service or qualified personnel. The technical specifications of your product appear on the technical data label.

**IMPORTANT:**

- This product must never be installed with its control panel at the top.
- This product must not be installed horizontally.
- During installation use wedges so that the control panel will not be in contact with the floor
- Please refer to Figure 2 for correct positioning.

Figure 2:

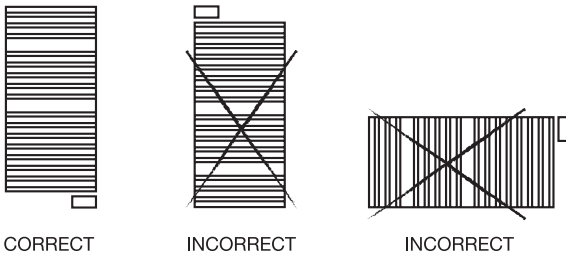

**3.3. Specific Regulations for bathrooms**

This product is in compliance with CLASS II safety regulations (double insulation). It can be installed according to Figure 3 (in positions A and B in areas 2 and 3 only) whenever it observes the following regulations:

- In bathrooms, the product must never be installed in such a way that the switches and other control products may be touched by persons in the bathtub or having a shower.
- In a kitchen or bathroom, the body of the product shall be placed at least 25cm from the floor.
- The product must not be earthed.

Figure 3:

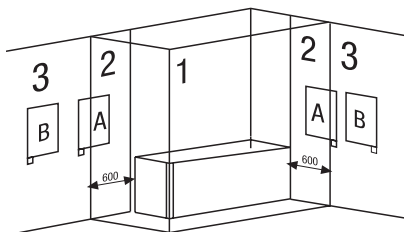



#### 4. Maintenance and cleaning

The product does not require any type of regular maintenance. However, we recommend that all parts of the product are kept clean (behind, underneath, along the rails etc.). Do not use any abrasive material/fluid on the product. Clean the product with a damp cloth and a pH neutral soap. Clean the control panel with a dry cloth.

#### 5. Installation and safety precautions (EN 60335 Standards)

Before switching on the product, please read the “Installation & Safety Precautions” in detail first to ensure the correct operation of the product.

##### 5.1. Installation precautions

The product is designed for household or residential use only. You are advised to have the product installed by an authorized professional installer. Please contact Rointe by telephoning 0203 321 5928 to find your nearest installer. Make sure the product is properly connected to 230V.

##### 5.2. Safety precautions

The product can be used by children aged from 8 years and above and by persons with reduced physical sensory or mental capabilities or lack of experience and knowledge, if they are supervised or have been given instruction concerning use of the product in a safe way and understand the hazards involved. The product is not a toy, children should not play with the product. Cleaning and user maintenance should not be carried out by children without supervision. Children must be supervised at all times to ensure that they do not interfere with the product.

If the power cable is damaged, it must be replaced by the manufacturer, its after-sales service or authorized personnel in order to avoid any damage.

#### 6. Rointe Product Guarantee

In this section, we hereby describe the guarantee conditions, which the buyer acquires, on buying this product from ROINTE. These conditions comply with all the rights construed in the national legislation in force, as well as any additional rights and guarantees, which are offered by ROINTE.

Any incident that you might detect in your ROINTE product can be sorted by the product seller or quickly by the manufacturer. Please **contact ROINTE by telephoning 0203 321 5929 for Technical Support**. Alternatively, you can **email ROINTE at support@rointe.co.uk**, through which we will instruct you on how to solve the incident.

You will need to state the product reference (located on the label indicating product features), serial number, proof of purchase and the type of incident at hand when contacting us so that we can check the guarantee. In addition, please attach a copy of the product invoice.

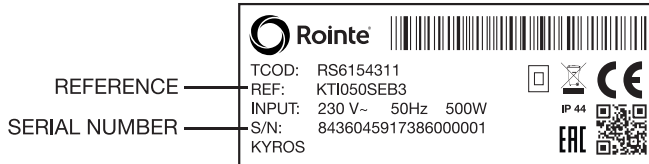

6.1. ROINTE guarantees that there are no material defects of design or manufacture at the time of original acquisition and guarantees the steel main body for a period of 120 months and any electronic and electrical components for 24 months, provided that they have not been modified in any way.

6.2. If during the guarantee period, the product does not work correctly under normal use, and any design, material or manufacturing defect is found, ROINTE will repair or substitute the product as it may see fit, in accordance with the terms and conditions as follows:

6.2.1. The guarantee is only applicable if the original guarantee is issued by the seller and when the said guarantee is filled in correctly including product reference, series number (marked on the product's label indicating technical features), purchase date and the seller's stamp, and either registered on our website at [www.rointe.co.uk](http://www.rointe.co.uk) or returned completed to ROINTE within 90 days of installation. ROINTE reserves the right to reject the guarantee service when this information has been removed or modified after the original product purchase.

6.2.2. The guarantee is only applicable if the product has been installed by a competent person in accordance with this installation manual and all current regulations and codes of practice at the time of installation.

6.2.3. The guarantee is only applicable to those cases that concern material, design and manufacturing defects, and under no circumstances covers damage to the product for the following reasons:

6.2.3.1 Damage caused by negligence and/or misuse of the product, i.e. used for other purposes that are not construed as its normal use or for not respecting the instructions of use and maintenance given by ROINTE as well as incorrect installation or use of the product that may not comply with the current technical standards of safety.

6.2.3.2. Corrosion of any part of the product caused by direct exposure to salt water. When the product is installed no more than 200m from the coast the guarantee for damages caused by corrosion the period will be reduced by 50%.

6.2.3.3. Any unauthorised modification of the product or repairs of the product carried out by third parties or unauthorised technicians or opening of the product by third parties or unauthorised people.



6.2.3.4. Any accidents that are deemed outside the control of ROINTE, such as (but not limited to): lightning, fires, floods, natural disasters, public disorder, atmospheric or geologic phenomena etc.

6.2.3.5. Faults that result from an incorrect installation. Guidance can be found within the recommendations for installation, by Rointe and in the installation manual. If in doubt, please contact ROINTE.

6.2.4. Any repairs or substitutions that are included in this guarantee do not allow any additions or new periods of guarantee.

6.2.5. Any repairs or substitutions covered under this guarantee must be parts that are functionally equivalent. The defective parts or parts removed or replaced shall become the property of ROINTE.

6.2.6. The product must be installed in a way that allows access for our technicians should they need to gain access to the product for repair or maintenance. The user/client is responsible for any costs or organisation required to provide access to the products for their repair and/or substitution.

6.3. The Technical Service department of ROINTE will advise you if you need to purchase any parts not covered under the guarantee or out of guarantee.

6.4. This guarantee will be null and void if the product: has been manipulated, modified and/or repaired in any way and/or by unauthorised persons. This guarantee will also be void if the product is not correctly installed.

6.5. This guarantee is not transferable and does not include claims due to frost or limescale damage.

6.6. Proof of purchase will be required to ROINTE for any claim.

6.7. This guarantee does not affect your statutory rights.

6.8. This guarantee does not affect the buyer's legal rights stipulated in the current national legislation, nor affects those rights against the distributor or installer that could come forth in compliance with the purchase contract.

6.9. In the absence of a national legal legislation applicable, this guarantee shall prevail and may be construed as the buyer's only protection. ROINTE, its offices, distributors and installers may not be held responsible for any accidental damage that emerges due to infringement of any rules implicitly related to this product.

For help about the product or guarantee, please **contact ROINTE by telephoning 0203 321 5929 for Technical Support** or by **email to support@rointe.co.uk**.

## 7. European Directive (WEEE) 2012/19/UE

Under the European Directive 2012/19/UE on Waste Electrical and Electronic Equipment (WEEE), the product cannot be disposed in the usual council bins and containers. They must be separated to optimize the recovery and recycling of all of the components and materials and reducing the impact to human health and the environment. The symbol of the container crossed out over a horizontal line is marked on all of ROINTE products to remind the consumer of the obligation to separate them on disposal. The consumer should contact the local authority or original point of sale to learn more about the correct disposal of this product.

## 8. Dimensions and technical characteristics

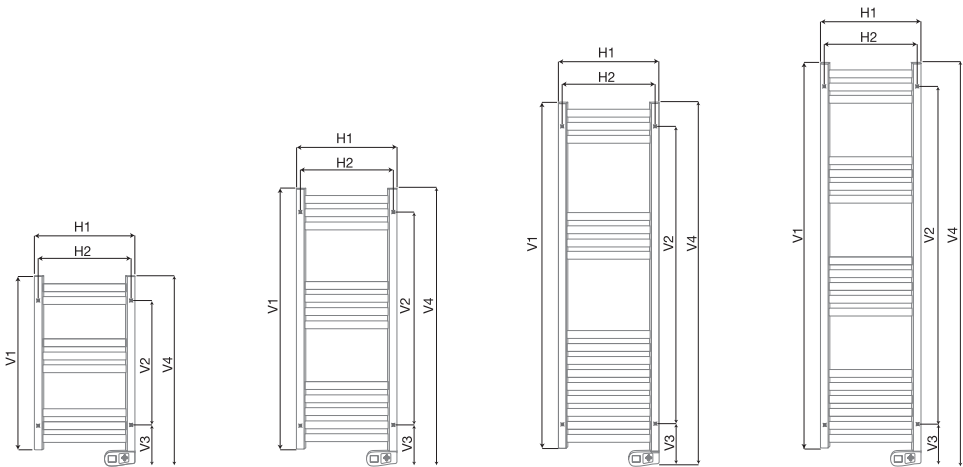

REFERENCE	H1 (mm)	H2 (mm)	V1 (mm)	V2 (mm)	V3 (mm)	V4 (mm)
KTI030SE*3	500	450	800	580	200	900
KTI050SE*3	500	450	1,200	980	200	1,300
KTI075SE*3	500	450	1,600	1,380	200	1,700
KTI100SE*3	500	450	1,800	1,380	200	1,900





MODEL		KTi030SE*3	KTi050SE*3	KTi075SE*3	KTi100SE*3
<b>DIMENSIONS</b>					
Width (mm)		500	500	500	500
Height without control panel (mm)		800	1,200	1,600	1,800
Height with control panel (mm)		900	1,300	1,700	1,900
Depth (mm)		50	50	50	50
Installed Depth (mm)		100	100	100	100
<b>WEIGHTS &amp; FINISHES</b>					
Weight (kg)		11	15	22	28
Finish		White RAL 9016 / Chrome			
<b>ELECTRICAL CHARACTERISTICS</b>					
Nominal Power (W)	White RAL 9016	300	500	750	1,000
	Chrome	300	300	500	750
Voltage (V)		230 ~V	230 ~V	230 ~V	230 ~V
Current (A)	White RAL 9016	1.3	2.2	3.3	4.4
	Chrome	1.3	1.3	2.2	3.3
<b>PERFORMANCE &amp; SECURITY</b>					
Safety thermostat		✓	✓	✓	✓
Protection Grade		IP44	IP44	IP44	IP44
Class II heating element		✓	✓	✓	✓
<b>INSTALLATION</b>					
Template & Installation Kit		✓	✓	✓	✓
EAN CODES	<b>WHITE RAL9016</b>	8436045917379	8436045917386	8436045917393	8436045917409
	<b>CHROME</b>	8436045917331	8436045917348	8436045917355	8436045917362



Cut along the dotted line



# CERTIFICATE OF GUARANTEE



In the event of any defect being detected in the product within the period of guarantee, you must fill in the below Certificate of Guarantee and send it to us stamped together with a copy of the sales invoice via email to [support@rointe.co.uk](mailto:support@rointe.co.uk) or to the following postal address: INDUSTRIAS ROYAL TERMIC, S.L., C/E, Parcela 43, 30140 Santomera (Murcia, Spain).

CERTIFICATE OF GUARANTEE	
REFERENCE:	N° SERIES: PURCHASE DATE:
USER:	
HOME ADDRESS:	
TOWN:	POSTCODE:
COUNTY:	COUNTRY:
TELEPHONE:	EMAIL:
SELLER'S STAMP:	

NB: This certificate of Guarantee MUST be completed in full in order to obtain guarantee rights. The purchase date and seller's stamp are compulsory. Please attach a copy of your sales invoices. In addition, for new constructions include the Certificate of First Occupation.









Thank you for choosing Rointe. We hope you enjoy your product.

If you require further assistance or information, please contact our Technical Service Department by telephoning **0203 321 5929** or email **[support@rointe.co.uk](mailto:support@rointe.co.uk)**.



**ROINTE UK**

Catalyst House,  
720 Centennial Court, Centennial Park  
Elstree, Herts, WD6 3SY

T. 0203 321 5928

F. 0208 953 5861

Technical Support

T. 0203 321 5929

E: [support@rointe.co.uk](mailto:support@rointe.co.uk)

[www.rointe.co.uk](http://www.rointe.co.uk)