

# Eclipse 100 & 150

- Wall or ceiling mountable
- Integral back draft shutter mechanism
- Meets current Building Regulations Approved Document F
- 100mm and 150mm size options
- Fixing kits available
- Fan IP44 rated -100mm
- Fan IPX4 rated -150mm



## Bathroom Ventilation

The Eclipse range of circular axial fans is designed to be installed in kitchens and bathrooms. Its simple design provides an unobtrusive fitting that is sympathetic with most interiors.

### Models

#### ECLIPSE 100X

Single speed 100mm bathroom/toilet fan with back draught shutter.

Model	Stock Ref
100X	427310

#### ECLIPSE 100XP

Single speed 100mm bathroom/toilet fan with pullcord and back draught shutter.

Model	Stock Ref
100XP	427281

#### ECLIPSE 100XT

Single speed 100mm bathroom toilet fan with integral adjustable overrun timer (5-30 minutes) and back draught shutter.

Model	Stock Ref
100XT	427282

#### ECLIPSE 150X

Single speed 150mm kitchen fan with back draught shutter.

Model	Stock Ref
150X	427283

#### ECLIPSE 150XP

Single speed 150mm Kitchen fan with pullcord and shutter.

Model	Stock Ref
150XP	427313

## Accessories

Model	Stock Ref
Bezel Chrome 100mm	436480
Bezel Silver 150mm	436483
Wall Kit White 150mm	140902
Wall Kit Brown 150mm	140903
Wall Kit White 100mm	254102
Wall Kit Brown 100mm	254100

## Dimensions (mm)

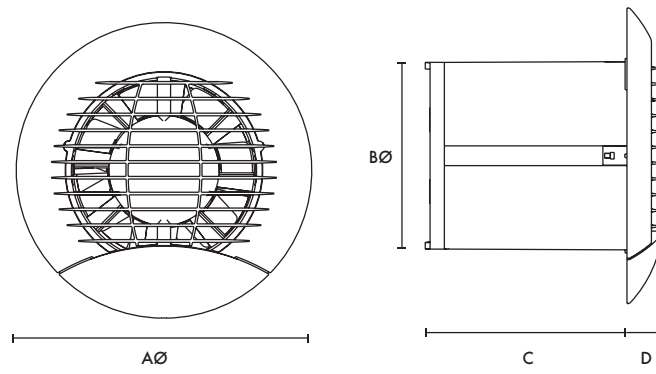

Model	AØ	BØ	C	D
Eclipse 100	157	99	107	19
Eclipse 150	201	144	123	19

## Performance

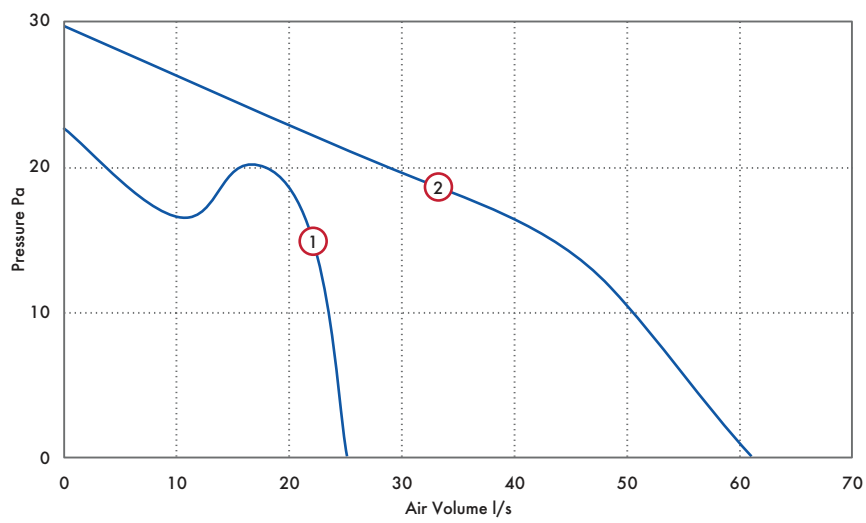

Model	Curve Ref	Extract Performance			dB(A) @ 3m	SFP (W/l/s) @ 0Pa
		m <sup>3</sup> /h	l/s	Watts		
Eclipse 100	①	90	25	14	38	0.49
Eclipse 150	②	220	61	16	45	0.25

Tested at 240V 50Hz