



EH0539

9000 BTU DC Inverter Window Air Conditioner
with Remote Controller & Timer



Important

These instructions should be read carefully and left with the user of the product for future reference.

Before Use

You must inspect the appliance including its cable and plug for any signs of damage. If the product is damaged, DO NOT use it and contact your supplier immediately.

Product Safety

- This appliance can be used by children aged from 8 years and above and persons with reduced physical, sensory or mental capabilities or lack of experience and knowledge if they have been given supervision or instruction concerning the use of the appliance in a safe way and understand the hazards involved.
- Children shall not play with the appliance.
- Cleaning and user maintenance shall not be made by children without supervision.
- Do not cover.
- Do not use on a boat, in a caravan or at other similar locations.
- Do not use in bathrooms or similar wet locations.
- Do not place on soft surfaces.
- Do not place a mains lead beneath a carpet or rug.
- Do not submerge the unit in water.
- Do not place the unit close to heat-generating devices or near flammable and dangerous materials.
- Never put your fingers or objects into the intake or discharge ducts.
- Do not sit or stand on the unit.
- If the power supply cord is damaged it must be replaced by the manufacturer or a qualified service agent.
- The item must be used in a room greater than 4m squared.

Regulatory Information

Safety, health and environmental regulations specific to gas R32
Labelling in accordance to Regulation EC 1272/2008

Hazard Pictograms



GHS02

GHS04

Signal Word :Danger

Hazard Statements

H220 Extremely Flammable Gas

H280 Contains gas under pressure, may explode if heated

Precautionary Statements

- P210 Keep away from heat/sparks/open flames/hot surfaces- No smoking
- P377 Leaking gas fire: Do not extinguish unless can be stopped safely
- P381 Eliminate all ignition sources if safe to do so
- P410 Protect from sunlight
- P403 Store in a well ventilated place.
- P501 Dispose of contents/container in accordance with local/regional/ National regulations.

● Installation

This item must be installed by a qualified refrigeration engineer.

A FULL SITE SURVEY MUST BE CARRIED OUT PRIOR TO INSTALLATION.

It is the responsibility of the installer to ensure the suitability of both the product for the installation and the installation location for the product.

Notes

The minimum safe distances must be observed when deciding on the installation location. See diagram below.

The product should be installed away from other heat sources or direct sunlight.

The product should be installed with observance to the product safety information.

The cut-out hole should be slightly bigger than the size of the unit. Due to slight changes in size, please ensure the unit is measured at the time of fitting.

The distance of any obstruction from the window unit inside should be upper 300mm, lower 1500mm, left 500mm, right 500mm, front 1500mm.

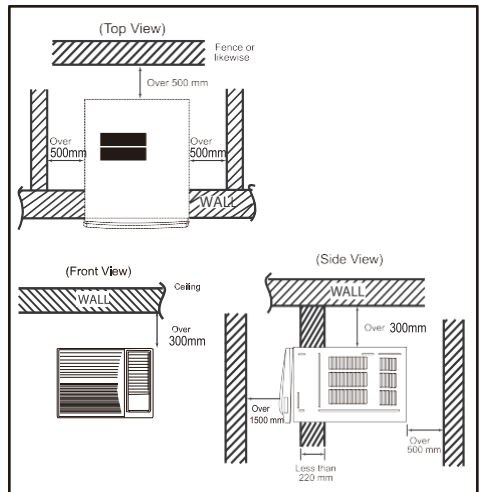

Installation Guide:

- 1) Remove the sticker from the front panel.
- 2) Put the unit into the installation hole.
 - When installing the unit, it should be slanted slightly down to the back to avoid vibration (as per the diagram)
 - The unit must be supported using appropriate brackets.

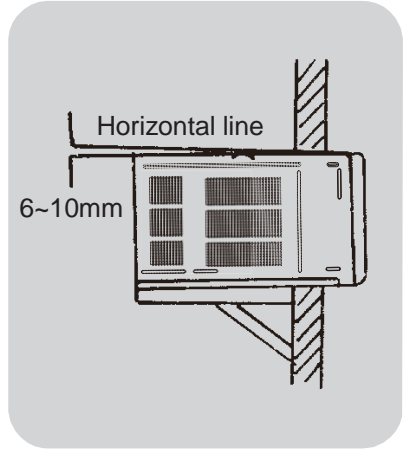

Use a sunshade board to stop items being dropped on to the unit and also to reduce exposure to direct sunshine.

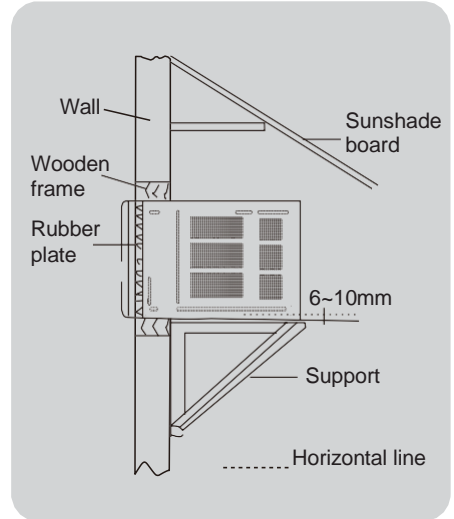

Drain water :

The drainhose is not included in this product.

The drainpan is included in this product.

1. Slide out the chassis from the cabinet.
2. Install the drain pan to the corner of the cabinet with 2 screws.
3. Connect the drain hose to the outlet on the drain pan bottom.
4. Slide the chassis into its original place in the cabinet.

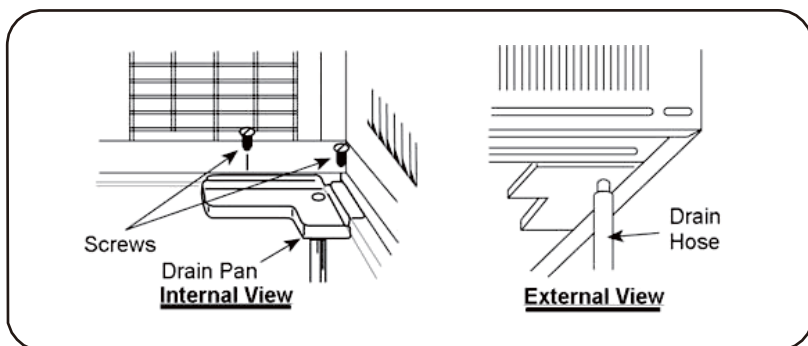

● Parts identification

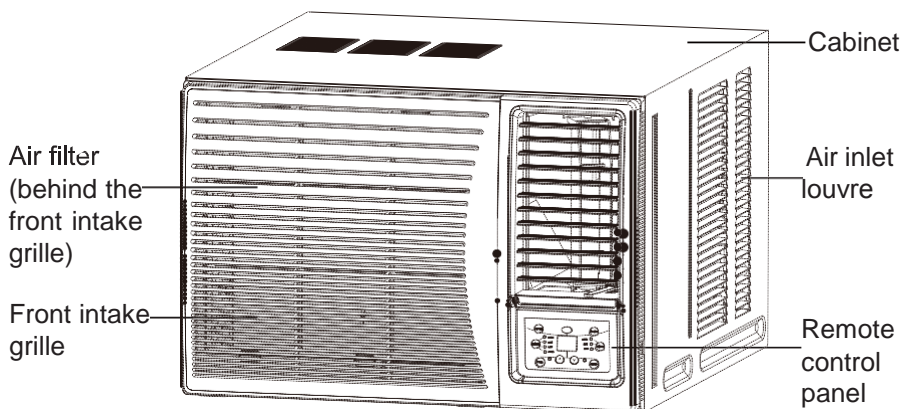

Air direction adjustment

Vertical airflow direction vane

(Airflow direction adjustment up and down).

The vertical airflow direction vane is controlled by positioning the vane to discharge the air upwards, downwards or straight out.

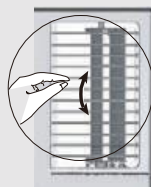

● Remote control operation procedure

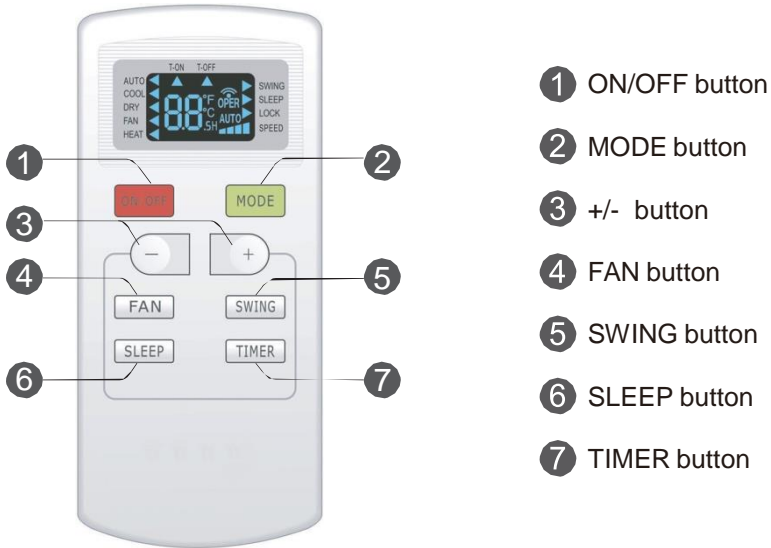

Introduction for icons on display screen

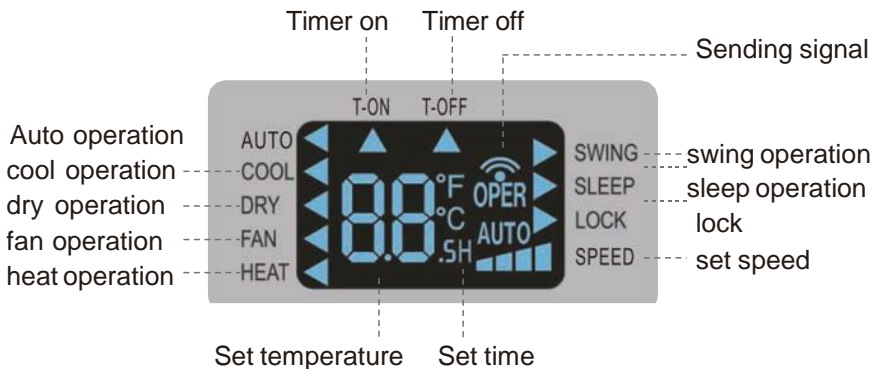

Introduction for buttons on remote control

Note:

- This is a universal remote control for all models in this series. Not all the functions on the control may be on your unit. Please check before using.
- When the power is connected and the unit is in standby mode you can operate the air conditioner with this remote control.
- Pressing a button on the remote control will cause the sending icon to flash. The unit will beep after receiving this instruction.

1 ON/OFF button

Press this button to turn unit on/off.

2 MODE button

Pressing this button once can select your required mode circularly as below (the corresponding icon "◀" will be lit up after the mode is selected):

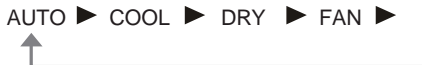

- When selecting auto mode, air conditioner will operate automatically according to ambient temperature. Set temperature can't be adjusted and won't be displayed either. Press FAN button to adjust fan speed.
- When selecting cool mode, air conditioner will operate under cool mode. Then press + or - button to adjust set temperature. Press FAN button to adjust fan speed.
- When selecting dry mode, air conditioner will operate at low fan speed under dry mode. In dry mode, fan speed can't be adjusted.
- When selecting fan mode, air conditioner will operate in fan mode only. Then press FAN button to adjust fan speed.

3 + / - button

- Pressing + or - button once will increase or decrease set temperature by 1°F(or °C). Hold + or - button for 2s, set temperature on remote controller will change quickly. Release the button after your required set temperature is reached.
- When setting Timer On or Timer Off , press + or - button to adjust the time.(See TIMER Button for setting details)

Introduction for buttons on remote controller

4 FAN button

Pressing this button can select fan speed circularly as: AUTO, SPEED 1 (▲), SPEED 2 (▲▲), SPEED 3 (▲▲▲), SPEED 4 (▲▲▲▲) (unavailable in this air conditioner. Speed 4 is the same with speed 3.).

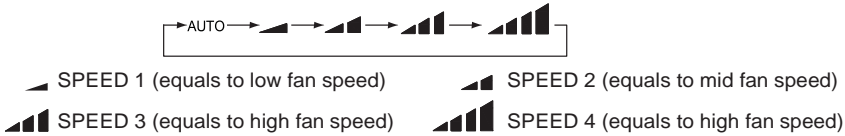

Note:

- Under Auto speed, air conditioner will select proper fan speed automatically according to ambient temperature.
- Fan speed can't be adjusted under Dry mode.

5 SWING button

Press this button to turn on left & right air swing.

6 SLEEP button

Under Cool mode, press this button to turn on Sleep function. Press this button to cancel Sleep function. Under Fan, Dry and Auto mode, this function is unavailable.

7 TIMER button

- When unit is on, press this button to set Timer Off. T-OFF and H icon will be blinking. Within 5s, press + or - button to adjust the time for Timer Off. Pressing + or - button once will increase or decrease the time by 0.5h. Hold + or - button for 2s, time will change quickly. Release the button after your required set time is reached. Then TIMER button to confirm it. T-OFF and H icon will stop blinking.
- When unit is off, press this button to set Timer On. T-ON and H icon will be blinking. Within 5s, press + or - button to adjust the time for Timer On. Pressing + or - button once will increase or decrease the time by 0.5h. Hold + or - button for 2s, time will change quickly. Release the button after your required set time is reached. Press TIMER button to confirm it. T-ON and H icon will stop blinking.
- Cancel Timer On/Off: If Timer function is set up, press TIMER button once to review the remaining time. Within 5s, press TIMER button again to cancel this function.

Introduction on remote control

Note:

- Range of time setting is: 0.5~24h
- The interval between two motions can't exceed 5s, otherwise the remote controller will exit setting status.

Function introduction for combination buttons

Child lock function

Press “+” and “-” buttons simultaneously can turn on or turn off child lock function. When child lock function is started up, LOCK indicator on remote controller is ON. If you operate the remote controller, remote controller won't send signal.

Temperature display switchover function

Under OFF status, press “-” button and “MODE” button simultaneously to switch between °C and °F.

Replacement of batteries in remote controller

1. Press the mark  on back cover of batteries box cover for remote controller with fingers as shown in the fig, and then remove the batteries box cover along the arrow direction.
2. Replace with two #7 (AAA 1.5V) dry batteries. Make sure positions for “+” pole and “-” pole are correct.
3. Replace batteries box cover.

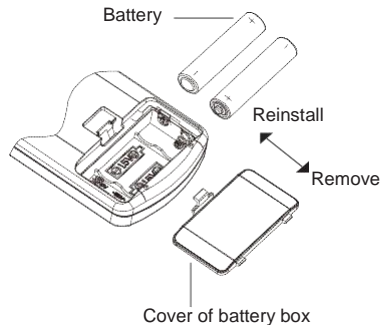

NOTICE

- The distance between remote control and unit should be no more than 8m, and there should be no obstacles between them.
- As the signal will be interfered in the room with electronic fluorescent lamp, conversion fluorescent lamp or wireless phone, please get closer to the air conditioner when using the remote controller.
- Replace new batteries of the same model when replacement is required.
- When you don't use remote controller for a long time, please take out the batteries.

Control panel

Note:

If wireless remote controller is lost, open the surface panel and operate manually.

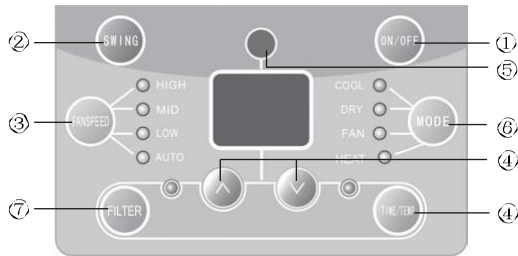
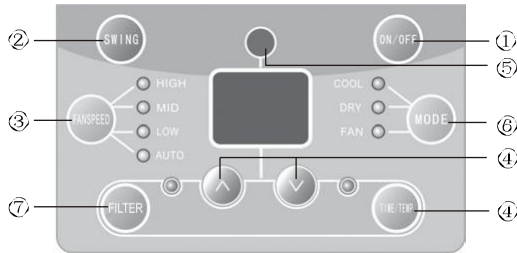

1 POWER BUTTON

Operation starts when pressing this button, and stops when pressing this button again.

2 SWING BUTTON

Activate the automatic air swing function.

3 FAN SPEED BUTTON

Select the fan speed HIGH, MID, LOW and AUTO in sequence.

4 TEMP/TIMER BUTTON

Press the ▲ keypad to increase the set (operating) temperature of the unit. And Press the ▼ keypad to decrease the set (operating) temperature of the unit. The temperature setting range is from 16~30℃

Timer can be set by pressing ▲/▼ button. Timer can be set in 0.5hour increments between 1 and 10 hours, or in 1hour increments for 10 hours or above after each push on ▲ or ▼ button.

5 SIGNAL RECEIVER

6 MODE BUTTON

Select the operation mode, AUTO, COOL, FAN, DRY (for reverse cycle model) or COOL,FAN, DRY (for cooling only model).

7 FILTER BUTTON

This feature is a reminder to clean the Air Filter (See Care and Cleaning) for more efficient operation and cooling. The LED (light) will illuminate after 250 hours of operation. To reset after cleaning the filter, press the "Check Filter" button and the light will go off.

● Operation Tips

Operation for comfort and economy

Do not overcool the room temperature. This is not good for health and wastes electricity

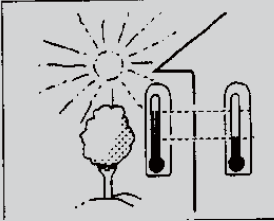

Reducing excessive sunlight entering the room will improve the cooling efficiency of the unit. Example, the use of blinds or curtains.

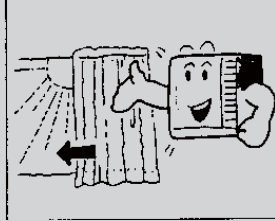

Adjusting the vertical and horizontal vents will help to keep an even room temperature.

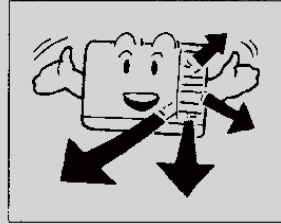

Keeping doors and windows closed will help to keep a room cool and save on energy costs.

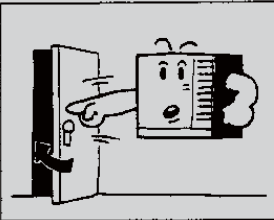

The air filter must be cleaned every 2 weeks or sooner if used in an area with a lot of airborne particles. This will improve the efficiency of the unit.

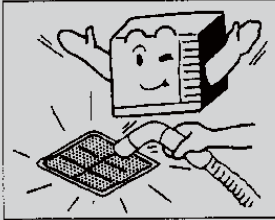

Rooms should be periodically ventilated, both when in use and when not in use.

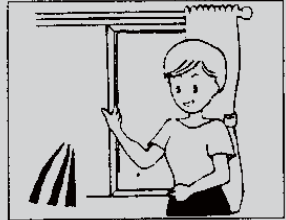

Always wait at least 3 minutes before switching the air conditioner on again after you have switched it off during cooling.







Care and maintenance

The air conditioner must be switched off at the mains and disconnected before any maintenance or cleaning.

Cleaning unit

- 1.) Disconnect from the mains before cleaning
- 2.) Use only a slightly damp clean cloth when cleaning the cabinet.
- 3.) Do not use any strong detergents or solvents for cleaning this unit.
- 4.) Do not splash water or cleaning agents into the unit.
- 5.) Clean the air filter behind the intake grill every two weeks or as is required.
 - a. Remove the air intake grill and pull the tab on the filter. Pull out.
 - b. Use a vacuum to clean the filter.
 - c. Wash the filter from the cleaner side under a tap.
 - d. Let the filter dry thoroughly before re-installing.
- 6.) Check before use that the intake is not blocked or obscured.

● Troubleshooting guide

Issue	Trouble-shooting
<p>Air conditioner dose not operate at all.</p> 	<ul style="list-style-type: none"> • Check the unit is plugged in and switched on. • Check the fuse or circuit breaker.
<p>Cooling efficiency is poor.</p> 	<ul style="list-style-type: none"> • Is air inlet or outlet blocked? • Is there any other heat source in the room? <ul style="list-style-type: none"> • Does the air filter need cleaning? • Check the fan speed is set to HIGH
<p>Foggy air flows out.</p> 	<ul style="list-style-type: none"> • At COOL mode operation, sometimes there is foggy air flowing out of indoor unit, this is because of the humidity of the room.
<p>The air conditioner operation is noisy.</p> 	<ul style="list-style-type: none"> • A flowing water sound is normal, this is the gas moving inside the unit. • For a noise that sounds like a shower: This is the sound of the dehumidifying water being processed inside the air conditioner unit.
<p>It seems that condensation is leaking from air conditioner.</p>	<ul style="list-style-type: none"> • Condensation occurs when the airflow from the air conditioner cools the warm room air.
<p>Air conditioner does not operate for about 3 minutes when restart.</p>	<ul style="list-style-type: none"> • This is to protect the mechanism. • Wait about three minutes and operation will begin.

Malfunction code	Solution
H1	Means defrosting status.
E2	Please contact professional person to deal with it.
H5	Please contact professional person to deal with it.
E5	Please contact professional person to deal with it.
H4	Please contact professional person to deal with it.
E4	Please contact professional person to deal with it.
H3	Please contact professional person to deal with it.
L9	Please contact professional person to deal with it.
H5	Please contact professional person to deal with it.
PL	Please contact professional person to deal with it.
PH	Please contact professional person to deal with it.
HC	Please contact professional person to deal with it.
LP	Please contact professional person to deal with it.
Fo	Please contact professional person to deal with it.
F3	Please contact professional person to deal with it.
F4	Please contact professional person to deal with it.
F5	Please contact professional person to deal with it.
F0	Please contact professional person to deal with it.
E6	Please contact professional person to deal with it.
F1	Please contact professional person to deal with it.
F2	Please contact professional person to deal with it.
U7	Please contact professional person to deal with it.

Note: If there are other malfunction codes, please contact your installer.

Immediately stop all operations and unplug, then contact installer

- Operation starts or stops abnormally.
- Fuse blows or circuit breaker frequently trips.
- Accidental ingress of liquid into air conditioner .
- Electrical cables are hot or cable cover breaks.



Safety operation of flammable refrigerant

• Qualification requirement for installation and maintenance

All maintenance must be carried out by a qualified refrigeration engineer.

Technical Specifications

Model	EH0539
Power	230V~
Cooling Capacity.....	2.70kW
Power Rating	782
Refrigerant Charge.....	R32/0.51Kg
Energy Rating.....	5.2
Annual Consumption	240kWh/a
Pressure (Discharge/Suction)	4.3/2.5MPa
Max. Pressure	4.7MPa
IP Rating (Indoor)	IP20
IP rating (Outdoor)	IP24
SPL Indoor	50dB
SPL Outdoor.....	56dB
Weight	43
Dimensions.....	560x560x710

The Refrigerant used in this appliance is R32. Refrigerant leakage contributes to climate change. Refrigerant with lower global warming potential (GWP) would contribute less to global warming than a refrigerant with higher GWP, if leaked to the atmosphere. This appliance contains a refrigerant fluid with a GWP equal to [2087]. This means that if 1 kg of this refrigerant fluid would be leaked to the atmosphere, the impact on global warming would be [2087] times higher than 1 kg of CO₂, over a period of 100 years. Never try to interfere with the refrigerant circuit yourself or disassemble the product yourself and always ask a professional.

Service Warranty

Prem-i-Air guarantees the product free from defects in materials and workmanship for a period of one year.

Should this unit be operated under conditions other than those recommended, at voltages other than the voltage indicated on the unit, or any attempts made to service or modify the unit, then the warranty will be rendered void.

The product you buy may sometimes differ slightly from illustrations.

The warranty is in addition to, and does not affect, your statutory rights.

If you have any problems with this product, please call our

Help Desk on (0845) 459 4816.



PREM-I-AIR Applianced Ltd

Lancots Lane, Sutton, St. Helens, Merseyside, WA9 3EX
www.prem-i-air.co.uk