



Product Registration

Register your warranty online
within 30 days of purchase.

www.devola.co.uk/warranty



10% OFF

Use this discount code on your next order

DEV10



Scan for technical details



devola.co.uk

Unit 1, Reedswood Park Road, Walsall, West Midlands. WS2 8DQ

Helpline 0800 043 4243 Email info@devola.co.uk

devola

Comfortable living everyday

Instruction Manual

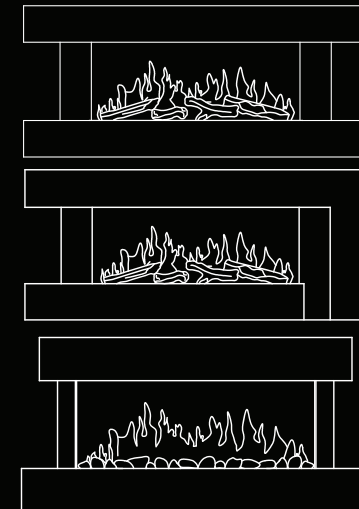

Electric Fireplace Suite

DVWF201GW/DVWF201G
DVWF202GW/DVWF02G
DVWF203W/DVWF203G



devola.co.uk

Warranty

Guarantee and service policy

This product is covered by a standard parts or replacement warranty for a period of 12 months from the date of purchase.

Extend your warranty for 12 months for free by visiting www.devola.co.uk/warranty.

Incorrect installation and failure to follow correct operating instructions are excluded. Consequential costs such as labour charges or damage to surroundings are expressly excluded.

Contact Us

If you experience a problem with this product you should first contact us on 0121 250 2180 before taking any further action.

CLAIM YOUR EXCLUSIVE 5% OFF YOUR NEXT ONLINE ORDER

DISCOUNT CODE: DEV5

OFFER VALID FOR 21 DAYS. DON'T MISS OUT!

YOUR DISCOUNT CODE ALSO APPLIES TO OURSISTER WEBSITES

Visit our websites:

www.devola.co.uk

www.energybulbs.co.uk

www.airconcentre.co.uk

www.ledbulbs.co.uk

Devola

USER MANUAL

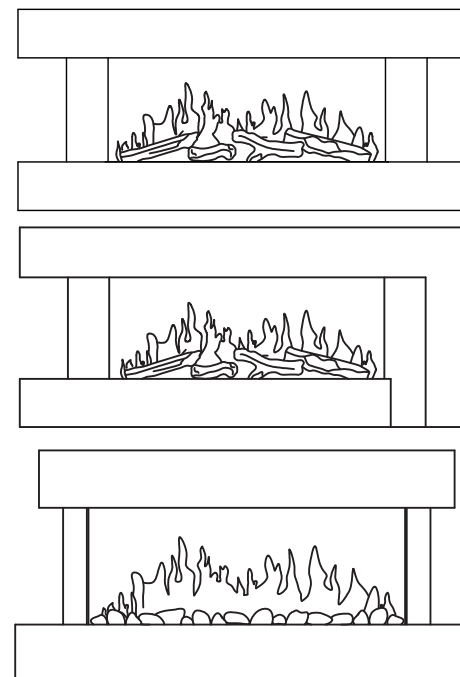

Electric Fireplace Suite

DVWF 201GW/DVWF 201G

DVWF 202GW/DVWF 202G

DVWF 203W/DVWF 203G

Thank you for choosing our Devola electric flame effect heater.

This manual aims to improve your understanding of your new heater, please read carefully before use and retain for future reference.

This product is only suitable for well insulated spaces or occasional use.

Item	Symbol	Value	Unit	Item	Unit
Heat Output				Type of heat input, for electric storage local space heaters only (select one)	
Nominal heat output	P _{nom}	2.0	kW	manual heat charge control, with integrated thermostat	No
Minimal heat output	P _{min}	1.0	kW	manual heat charge control with room and/or outdoor temperature feedback	No
Maximum continuous heat output	P _{max}	2.0	kW	electronic heat charge control with room and/or outdoor temperature feedback	No
Auxiliary electricity consumption				fan assisted heat output	No
At nominal heat output	e _{lmax}	1.898	kW	Type of heat output/room temperature control (select one)	
At minimum heat output	e _{lmin}	0.990	kW	single stage heat output and no room temperature control	No
In standby mode	e _{lsb}	0.00043	kW	two or more manual stages, no room temperature control	No
				with mechanical thermostat room temperature control	No
				with electronic room temperature control	No
				with electronic room temperature control plus day timer	No
				with electronic room temperature control plus week timer	Yes
				Other control options (multiple selections possible)	
				room temperature control with presence detection	No
				room temperature control, with open window detection	Yes
				with distance control option	No
				with adaptive start control	No
				with working time limitation	Yes
				with black bulb sensor	No
Contact Details					

CONTENTS

	Page
PARTS SUPPLIED	2
SAFETY INFORMATION	3
ELECTRICAL SAFETY	5
PRODUCT DIAGRAM	6
INSTALLATION INSTRUCTIONS	7
OPERATION	8
DISPLAY	8
REMOTE CONTROL	9
CARE AND MAINTENANCE	10
TROUBLESHOOTING	11
SERVICING	11
TECHNICAL SPECIFICATION	11
WASTE ELECTRICAL RECYCLING	12
SUPPORT	12
WARRANTY	15

PARTS SUPPLIED

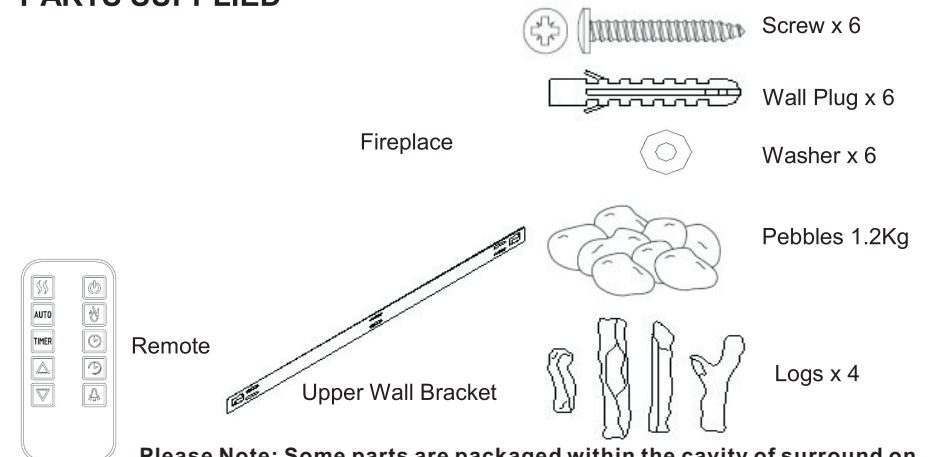

Please Note: Some parts are packaged within the cavity of surround on the rear of the fire.

SAFETY INFORMATION

When using electrical appliances, basic safety precautions should always be followed, including the following:

- **IMPORTANT:** Read all instructions and warnings carefully before starting installation. Failure to follow these instructions may result in a possible electric shock or fire hazard and will void the warranty.
- Before connecting the appliance, be sure that the mains voltage available matches that specified on the rating plate, and that the outlet is suitably grounded.
- This appliance should only be used by children aged 8 years and above and persons with reduced physical and mental capabilities if they are supervised or have been given clear instructions of how to use it safely. These individuals should be aware of any hazards that are involved when operating the appliance.
- Children aged 3+ (younger than 8 years) should only switch the appliance on and off, provided it has been safely installed in its intended operating position. Children of this age should be supervised and given instructions on safe use of the appliance, as well as being aware of the associated hazards. Children of said age should not plug in, regulate, clean or perform maintenance on the appliance.
- Children under 3 years should be kept away unless continuously supervised.
- Some parts of this product can become very hot and cause burns. Particular attention has to be given where children and vulnerable people are present.
- If the supply cord is damaged, it must be replaced by the manufacturer, its service agent or a similarly qualified person in order to avoid a hazard.
- **WARNING:** In order to avoid overheating, do not cover the heater.
- **CAUTION:** In order to avoid a hazard due to the inadvertent resetting of the thermal cut-out, this appliance must not be supplied through an external switching device, such as a timer, or connected to a circuit that is regularly switched on and off by the utility.
- Do not attempt to repair, disassemble or modify the appliance. This unit contains no user-serviceable parts.
- Always unplug or disconnect the appliance from the mains power supply when not in use, or when moving or cleaning it. Do not pull the cord to unplug the heater.
- Keep the heater clean. Do not allow any object to enter the ventilation or exhaust opening as this may cause electric shock, fire, or damage to the heater.
- Do not use the appliance for other than its intended use. It is designed for domestic indoor use only.
- There may be a trace of odour during the first few minutes of initial use, or after a period of storage. This is normal and will quickly disappear.
- If the glass is damaged, do not use the heater in order to avoid a hazard.
- Avoid the use of an extension cord, as the cord may overheat and cause a risk of fire.
- This fireplace is hot when in use. To avoid burns, do not let bare skin touch any hot surfaces.

WASTE ELECTRICAL RECYCLING



This symbol indicates that this product is classed as Electrical or Electronic Equipment and should not be disposed of with other household waste.

The Waste Electrical and Electronic Equipment (WEEE) Directive has been introduced across the European Union for the following purposes:

1. To recycle waste electrical products using the best available recovery and recycling techniques in order to minimize the impact on the environment.
2. To treat any hazardous substances.
3. To avoid increasing landfill.

WEEE products should be disposed of by handing it over at a designated collection point. **For more information about where you can drop off your waste product for recycling, please contact your local authority.**

SUPPORT

For your own convenience, please make these simple checks before you contact us or other aid.

1. Check that the unit is plugged into the mains.
2. Check that the fuse is OK.
3. Switch the unit off and wait ten minutes to see if the issue is resolved. Restart the unit.

If the above steps do not resolve the issue feel free to contact our customer support team on 0121 250 2180.



TROUBLESHOOTING

Most problems are simple to resolve - please refer to the following table before calling a service engineer:

Problem	Possible Cause	Check
Fire has stopped working	The fire has overheated and the thermal safety device has activated or a circuit breaker has tripped.	Check there is power to the socket where the fire is connected. Check the fuse in the plug. Check the main power switch on the unit is turned on and leave for 10 minutes in case of thermal cut-out.
Flame is not moving	Flame motor defective	Contact the retailer or manufacturer.

SERVICING

It is hazardous for anyone, other than a qualified service technician, to carry out any service or repair operation, which involves removal of any components. The lighting for the flame effect is by LED bulbs which are designed to last for the life of the product and are not user replaceable.

TECHNICAL SPECIFICATION

Description of Product	Electric Fireplace Suit	
Model	DVWF201GW/DVWF201G	DVWF202GW/DVWF202G
Rated Voltage	220-240V ~	220-240V ~
Rated Frequency	50 Hz	50 Hz
Rated Power	Max 2000W	Max 2000W
Dimensions (W) x (H) x (D)	1320 x 580 x 210 mm	1320x 580 x 210 mm
Weight	21.79Kg	24.15Kg
Model	DVWF203W/DVWF203G	
Rated Voltage	220-240V ~	
Rated Frequency	50 Hz	
Rated Power	Max 2000W	
Dimensions (W) x (H) x (D)	1170 x 580 x 210 mm	
Weight	26Kg	

- Keep combustible materials at least 1 metre from the front and sides of this appliance.
- This appliance is designed for indoor use only and is not intended for use in bathrooms, laundry areas and similar indoor locations. Never locate this appliance where it may become exposed to water.
- Do not place this fire directly onto a carpeted surface to avoid discolouration due to the heat.
- Do not run the cord under carpeting. Do not cover the cord with throw rugs or runners etc. Ensure the cord is kept away from traffic areas, and kept in a position which would not present a trip hazard.
- To disconnect this appliance, press the On/Off button to turn off, then remove the plug from the outlet.
- This appliance has hot and arching or sparking parts inside. Do not use it in areas where gasoline, paint, or any flammable liquids are used or stored.
- This appliance should not be used as a drying rack for clothing, nor should Christmas stockings or decorations be hung on or near it.
- This electric fire is an instant heat source to warm up a room and is great for visual room ambiance it doesn't necessarily need to be used as a constant or permanent source of heating for the home.
- Clean the fire regularly to prevent the build-up of hairs dust or lint around the fire, as this may cause the outlet to become blocked.
- Do not use aerosols or steam cleaners on or around the fire.

Manual Handling

- The heater must not be moved while in use. Please allow a suitable amount of time for the unit to cool before attempting to move it.
- One person should be sufficient to lift the heater. If for any reason it is considered too heavy then obtain assistance.
- When lifting always keep your back straight. Bend your legs and not your back.
- Avoid twisting at the waist. It is better to reposition your feet.
- Avoid upper body / top heavy bending. Always bend from the knees rather than the waist. Do not lean forward or sideways whilst handling the heater.
- Always grip with the palm of the hand. Do not use the tips of fingers for support.
- Always keep the heater as close to the body as possible. This will minimize the cantilever action.
- If required, use gloves to provide additional grip.
- Always use assistance if required.

ELECTRICAL SAFETY

The heater must not be located under an electrical socket, the socket must always be accessible in order to disconnect the heater from the electrical supply for maintenance and cleaning.

Important! This heater must be earthed. The mains supply must be safely routed from the heater to an electrical socket.

If the supply cord is damaged, it must be replaced by the manufacturer, service agent or a similarly qualified person in order to avoid a hazard.

This appliance is supplied with a BS1363 3 pin plug fitted with a 13 Amp fuse. Should the fuse require replacement, it must be replaced with a fuse rated at **13 Amp** and approved to BS1362.

In the event the mains plug has to be removed or replaced for any reason, please note:

The wires in the mains lead on this appliance are coloured in accordance with the following code:

Green and Yellow - Earth
Blue - Neutral
Brown - Live

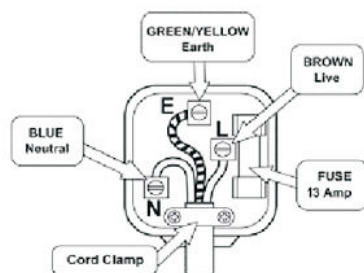

As the colours may not correspond with the markings identifying the terminals in your plug, please proceed as follows.

- The green and yellow wire must be connected to the terminal in the plug which is marked with the letter E or with the earth symbol \perp or coloured green and yellow.
- The blue wire must be connected to the terminal marked N or coloured black.
- The brown wire must be connected to the terminal marked L or coloured red.

Important - any cut off plug should be disposed of safely to prevent a hazard. There is a danger of electric shock if a cut off plug is inserted into a socket outlet.

CARE AND MAINTENANCE

When cleaning unit, the power supply should be disconnected and the unit should be cool.

Dust can be removed by lightly wiping the glass surface with a clean, lint free cloth or paper towel. To remove fingerprints or other marks, use a damp cloth with a good quality household glass cleaner. The front glass panel should be completely dried before reusing the heater.

⚠ CAUTION:







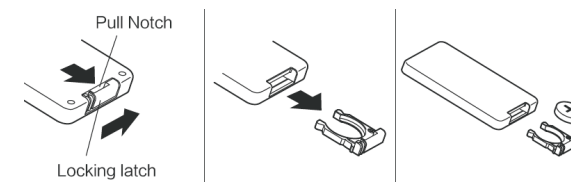



- Do not use abrasive cleaner on glass panel.
- Do not spray liquids directly onto any surface of the unit.
- Do not clean the glass on the inside of the unit as this may cause damage to the surface

REPLACING THE BATTERIES

The remote control takes a CR2025 battery. If the remote becomes unresponsive, please change the battery with a new battery, as shown in the image.



REMOTE CONTROL

Power Button		Press to turn the appliance On and Off.
Flame Button		Press to cycle between the three flame effects.
Arrow Buttons	 	Use to change the desired room temperature. The temperature currently selected will appear on the display. The heating range is between 16 and 30 °C.
Heating Level Button		Press to change between the available heating levels. Note – you must press the flame button beforehand, but once you have selected the heat setting you can switch the flame effect if necessary.
Downlight		To turn the downlights On/Off. This button is not valid for DVWF203W/ DVWF203G.
Timer Button		Press to turn the pre-scheduled weekly timer On/Off.
Clock		Before using the weekly timer, the clock must be set. To do this: Press the clock button, then use the arrow buttons to select the day. Press the clock button again, then use the arrow buttons to select the hour value (24-hour format). Press clock again, then use the arrow buttons to select the minute value.
Week Timer		<p>Your fire includes a 7-day timer, which allows you to set two periods of operation per day.</p> <p>To set the timer press the Week Timer button. The unit will display the current day, period, and if you are setting the On or Off time. For each period both an On and Off time must be set.</p> <p>Setting the timer:</p> <ol style="list-style-type: none"> 1. Set the start-up hour value using the arrow buttons, press the Week Timer button to confirm. 2. Set the start-up minute value using the arrow buttons, press the Week Timer button to confirm. Please note the minute values can only be set in 10-minute increments. 3. The fire will then move onto the next period (first period of the following day), allowing this to be programmed the same way. Follow this procedure if you want to schedule different start-up and shutdown times each day, however, you can set the same timer across multiple days using the arrow buttons. The up arrow allows you to cycle through the days, whilst pressing it twice skips a day. The down arrow is used to select the days you wish to set the timer for. 4. Set the shutdown hour value using the arrow buttons, press the Week Timer button to confirm. 5. Set the shutdown minute value using the arrow buttons, press the Week Timer button to confirm. 6. Again, if you wish to use the same second daily timer schedule across multiple days, follow the steps in point 3. <p>To clear an operational period set the ON and OFF times to the same value. You must set heating period 1 for the required days before you can set the second heating periods.</p>
Open Window Detection		Your fire has an 'Open Window Detection' function, whereby heating will automatically cease after a period if the room temperature is not increasing, on the assumption that there is an open window or door. This feature is designed to save energy and can be turned on or off using the AUTO button. When the function is activated, AUTO will appear on the display.

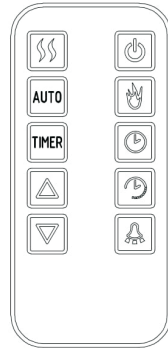

PRODUCT DIAGRAM

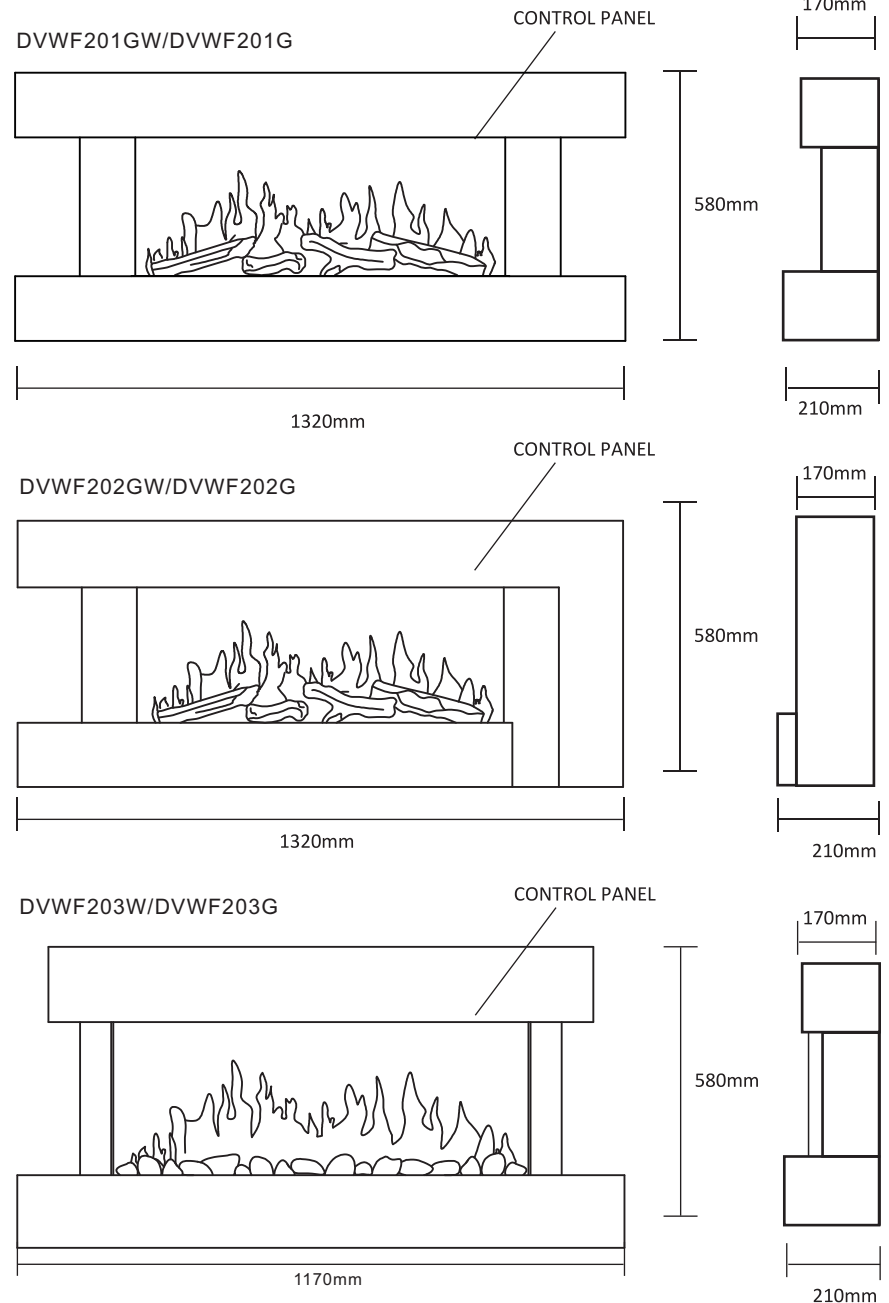

BEFORE USE!

Before using the appliance for the first time, ensure that it has been fully unpacked, and that all packaging has been disposed of properly to ensure it does not present a risk to children or animals.



Due to the size and weight of the fire, we would advise on 2 people carrying out installation to prevent injury or damage.

INSTALLATION INSTRUCTIONS

This product is designed to be mounted flat to the wall. Before installation please ensure that the floor and wall are flat, and there is nothing that would prevent the fire fitting flush.

1. The fire is designed to be permanently fixed to a wall with a minimum distance of 300mm between the base of the fire and the floor. A distance of 600mm is recommended for the optimum height on the wall.
2. The upper bracket should be placed against the wall 490mm above the planned position of the base of the fire.
3. While ensuring that the bracket is level (using a spirit level) mark the position of the six screw holes in the wall.
4. Put the bracket to one side, drill the holes marked in step 3 with an 8mm drill bit to a depth of around 35mm.
5. Clean any dust and debris from drilling, and insert a wall plug into each hole, ensuring they are flush with the surface of the wall.
6. Hold the bracket in position and attach to the wall using 6 screws.
7. Two people should carefully lift the fire into position, ensuring the top edge of the fire engages with the bracket.
8. Spread the supplied pebbles / branches (model dependent) in position on the light at the front of the unit.

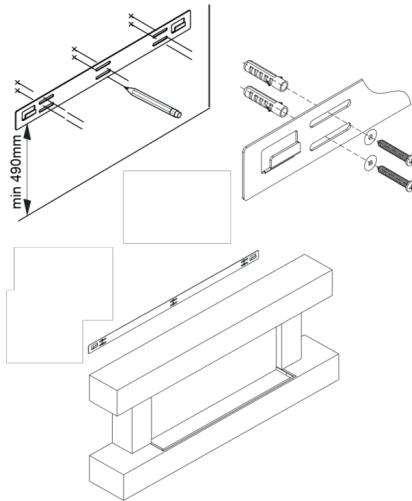

NOTES:

The wall plugs supplied are designed for solid walls, and so depending on the type of wall, a different type of plug may be required. Before drilling into the wall, you must ensure that there is no pipework or wiring behind the wall which may be damaged during installation. The fire must be installed by a competent person, if in any doubt about installation, the suitability of the wall, or wall plugs supplied, professional advice should be sought.

OPERATION CONTROL PANEL

HIGH HEAT

Press to put the unit in high heating mode (2kw).

LOW HEAT

Press to put the unit in low heating mode (1kw).

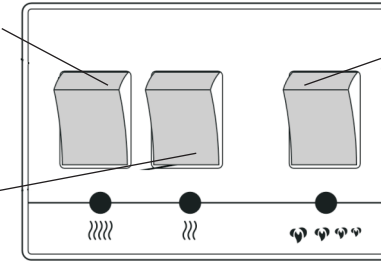

FLAME EFFECT

Press to change between the flame effects.

MAIN POWER SWITCH



DISPLAY

Weekday:

Shows current day, or currently selected day while setting the timer.

T1 / T2:

Two periods of operation can be selected per day. The currently selected timer will be shown.

HEATING LEVEL:

One bar indicates Low (1kw). Two bars indicates High (2kw).

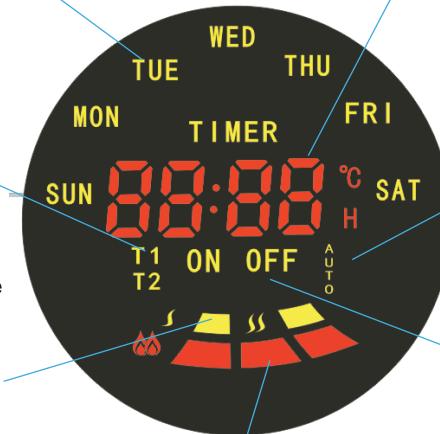

DISPLAY:

Shows the room temperature, temperature set while changing desired temperature, or during setting the timer will show the on or off time (indicated by the On/Off lights).

AUTO:

Shows if the window detection function is active.

ON/OFF:

Shows whether the timer is on or off.

FLAME EFFECT

Indicates which flame effect has been selected.